

Standard Kitchen Dimensions And Layout

engineeringdiscoveries.com/standard-kitchen-dimensions-and-layout

Engineering Discoveries

January 10, 2019

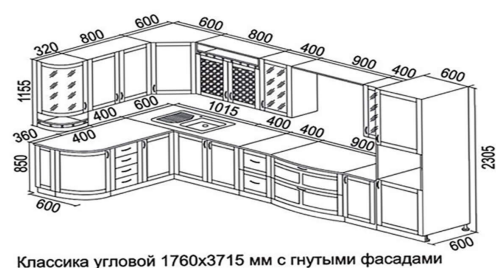
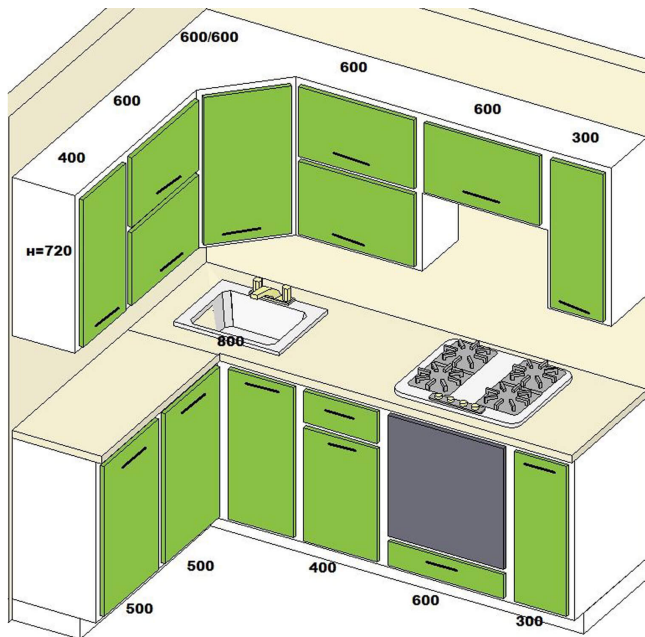

After the family room, the kitchen is one of the most used places in a house. From its core functionality of being the space for cooking food, to a practical place for washing utensils and dishes to an area where the family gets together and sits for a hearty meal. It is one of the most popular sociable spaces in the house. Here are some helpful guides about kitchen dimensions and kitchen planning guidelines for kitchen layouts.

[Click Here To See Let Kitchen Design Concepts Help You Create A Kitchen That's Right For Your Lifestyle](#)

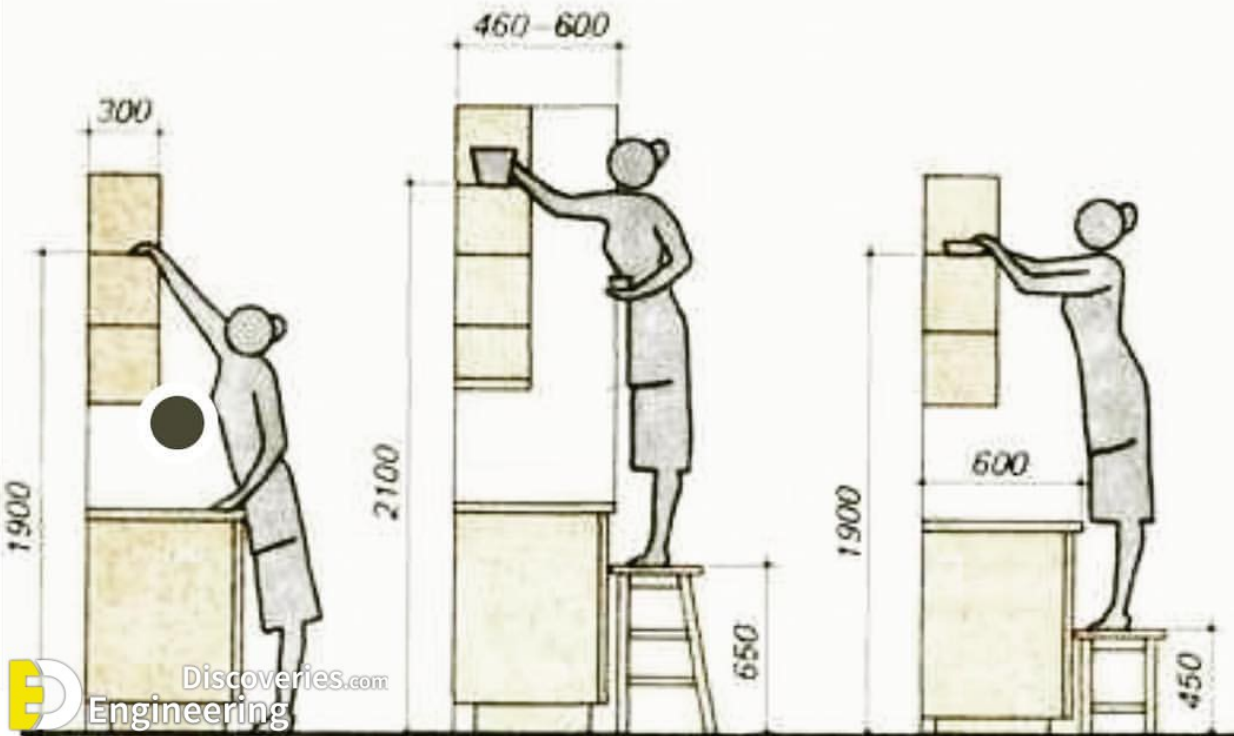
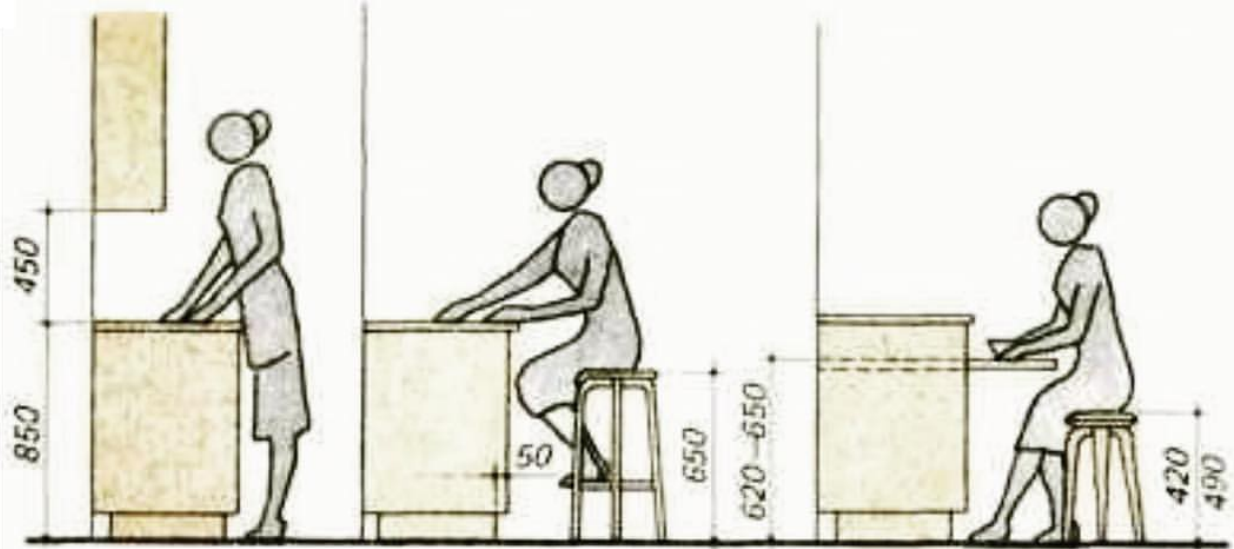

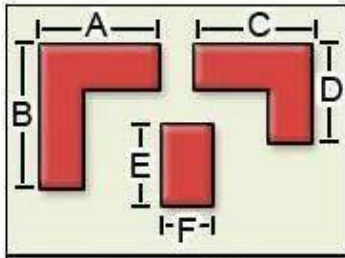

Layout #1

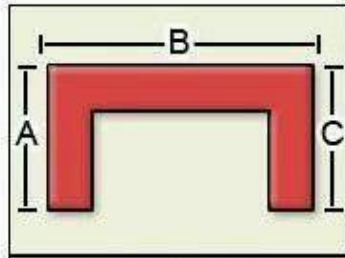

Layout #2

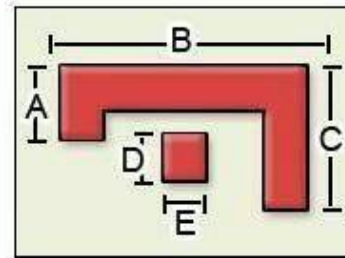

Layout #3

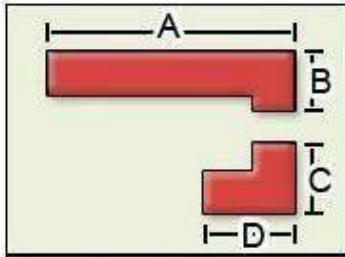

Layout #4

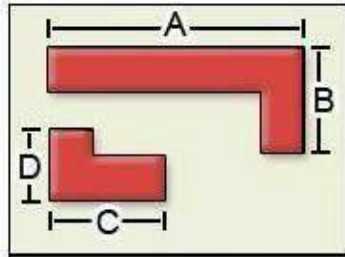

Layout #5

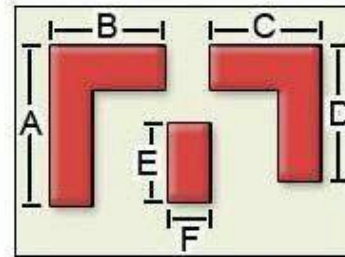

Layout #6

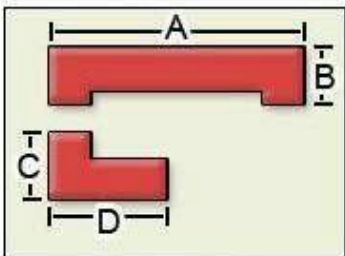

Layout #7

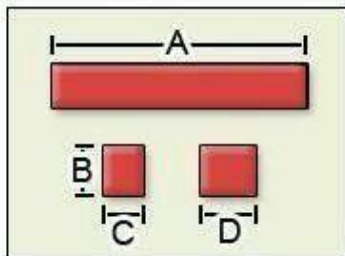

Layout #8

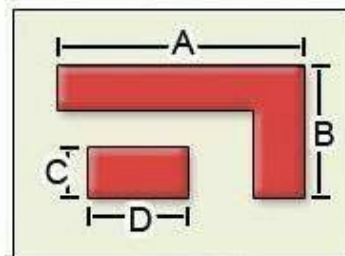

Layout #9

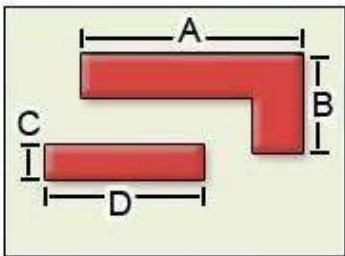

Layout #10

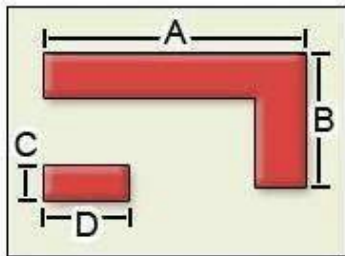

Layout #11

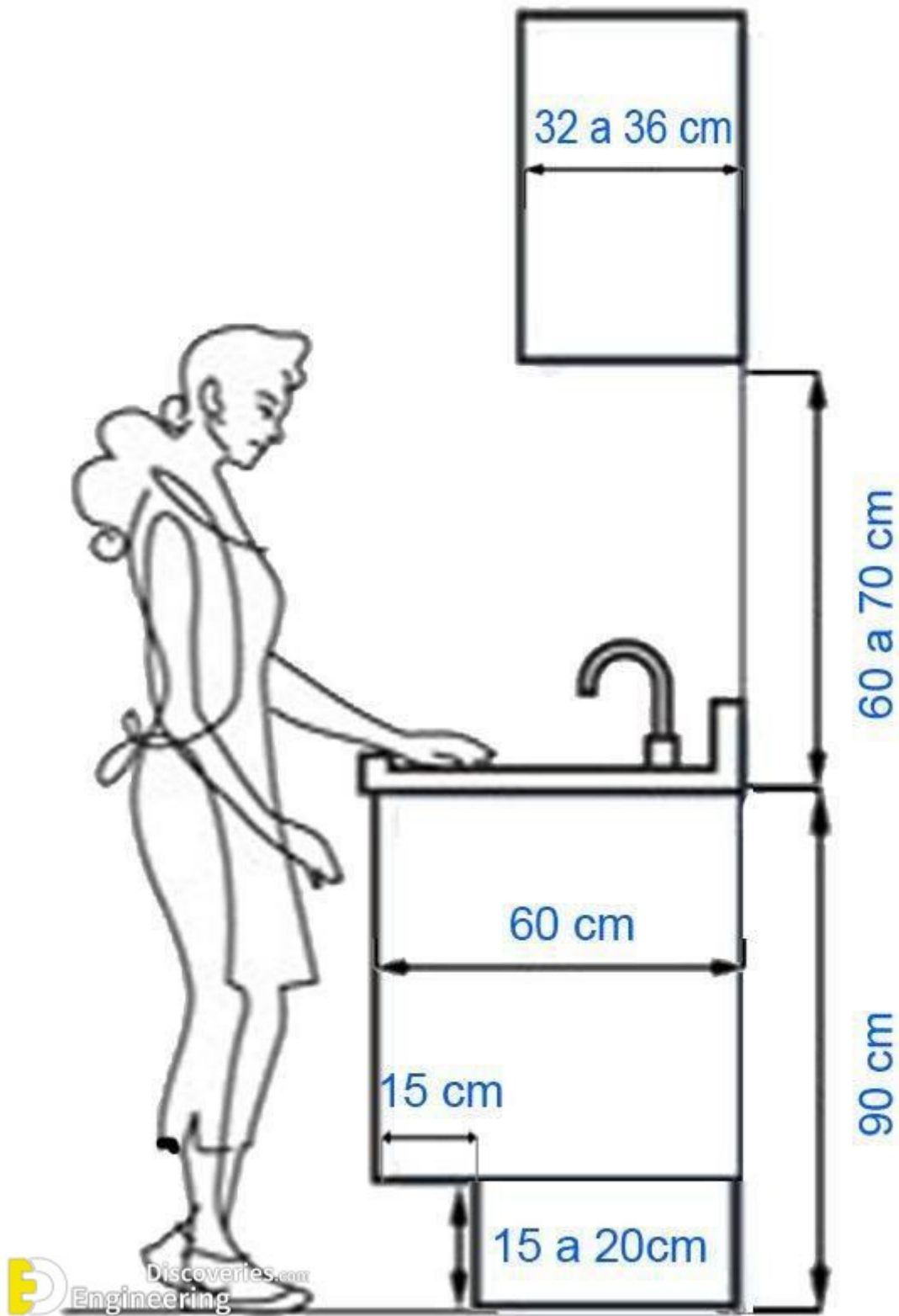

Standard Kitchen Layouts

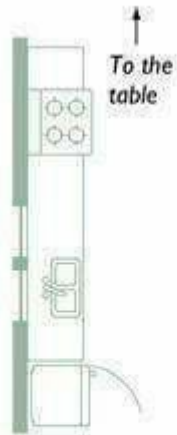

One Wall

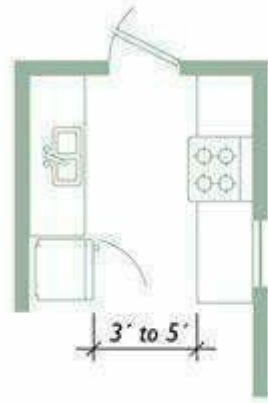

The Galley

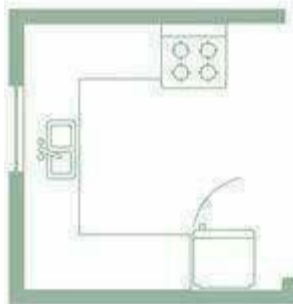

The U

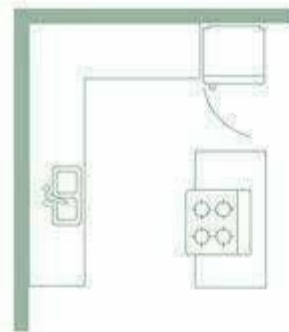

The Island

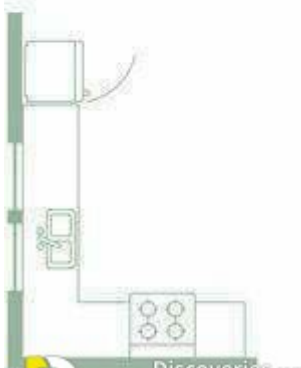

 Discoveries.com
Engineering
The L

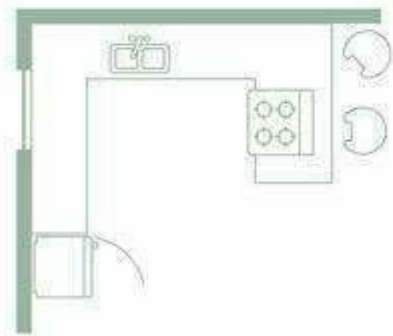

The Peninsula

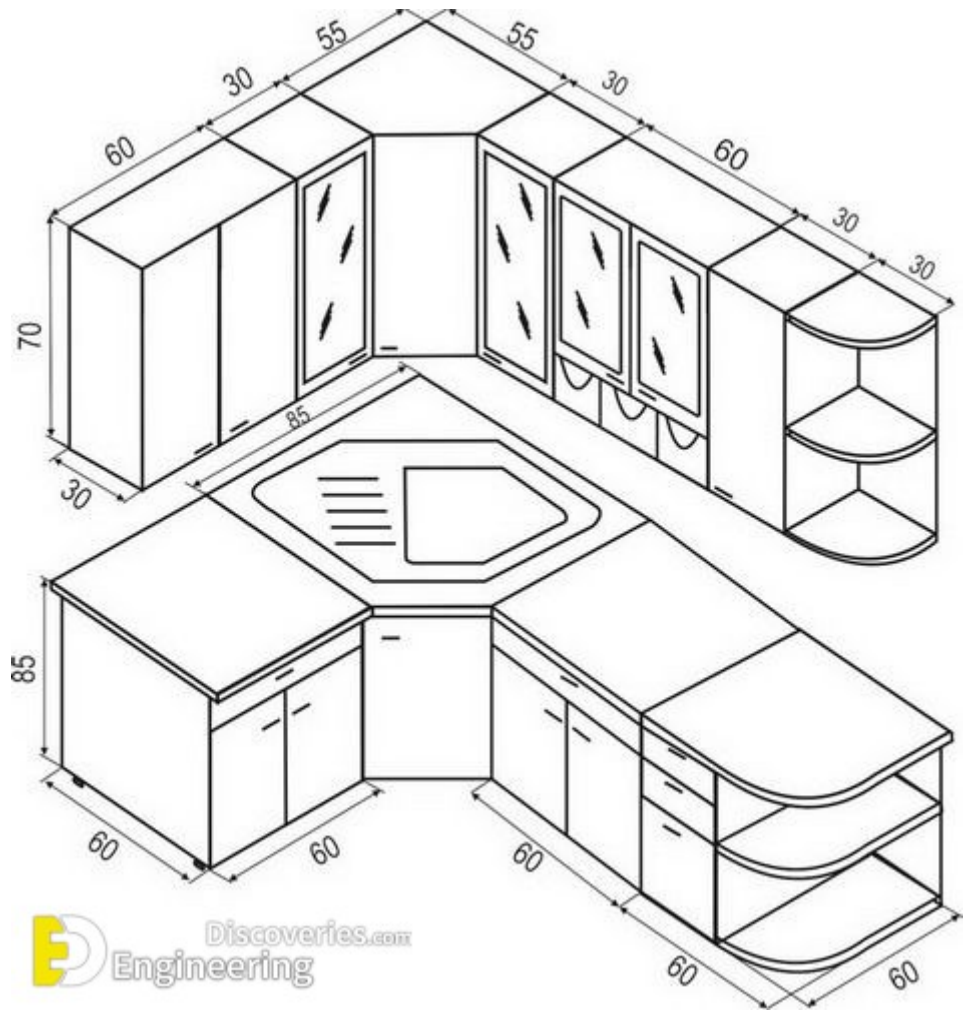

 Discoveries.com
Engineering

