

DOCTRINAL IMBALANCE: A STUDY OF SWEDISH ARMY DOCTRINE

A thesis presented to the Faculty of the U.S. Army  
Command and General Staff College in partial  
fulfillment of the requirements for the  
degree

MASTER OF MILITARY ART AND SCIENCE  
Art of War Scholar

by

MAGNUS FRYKVALL, MAJOR, SWEDISH ARMY  
B.A., Swedish National Defense College, Stockholm, Sweden, 2011

Fort Leavenworth, Kansas  
2014-01

Approved for public release; distribution is unlimited.

<b>REPORT DOCUMENTATION PAGE</b>			<i>Form Approved</i> <i>OMB No. 0704-0188</i>		
Public reporting burden for this collection of information is estimated to average 1 hour per response, including the time for reviewing instructions, searching existing data sources, gathering and maintaining the data needed, and completing and reviewing this collection of information. Send comments regarding this burden estimate or any other aspect of this collection of information, including suggestions for reducing this burden to Department of Defense, Washington Headquarters Services, Directorate for Information Operations and Reports (0704-0188), 1215 Jefferson Davis Highway, Suite 1204, Arlington, VA 22202-4302. Respondents should be aware that notwithstanding any other provision of law, no person shall be subject to any penalty for failing to comply with a collection of information if it does not display a currently valid OMB control number. <b>PLEASE DO NOT RETURN YOUR FORM TO THE ABOVE ADDRESS.</b>					
<b>1. REPORT DATE (DD-MM-YYYY)</b> 13-06-2014		<b>2. REPORT TYPE</b> Master's Thesis		<b>3. DATES COVERED (From - To)</b> AUG 2013 – JUN 2014	
<b>4. TITLE AND SUBTITLE</b>  Doctrinal Imbalance: A Study of Swedish Army Doctrine			<b>5a. CONTRACT NUMBER</b>		
			<b>5b. GRANT NUMBER</b>		
			<b>5c. PROGRAM ELEMENT NUMBER</b>		
<b>6. AUTHOR(S)</b>  Major Magnus Frykvall			<b>5d. PROJECT NUMBER</b>		
			<b>5e. TASK NUMBER</b>		
			<b>5f. WORK UNIT NUMBER</b>		
<b>7. PERFORMING ORGANIZATION NAME(S) AND ADDRESS(ES)</b> U.S. Army Command and General Staff College ATTN: ATZL-SWD-GD Fort Leavenworth, KS 66027-2301			<b>8. PERFORMING ORG REPORT NUMBER</b>		
<b>9. SPONSORING / MONITORING AGENCY NAME(S) AND ADDRESS(ES)</b>			<b>10. SPONSOR/MONITOR'S ACRONYM(S)</b>		
			<b>11. SPONSOR/MONITOR'S REPORT NUMBER(S)</b>		
<b>12. DISTRIBUTION / AVAILABILITY STATEMENT</b> Approved for Public Release; Distribution is Unlimited					
<b>13. SUPPLEMENTARY NOTES</b>					
<b>14. ABSTRACT</b> The Swedish Army has been significantly reduced during the last two decades. Despite the decreasing numbers of available forces, Swedish Army doctrine has remained essentially the same, built upon offensive concepts such as maneuver warfare and local superiority. This study uses a combination of qualitative analysis using military theory, and quantitative analysis using a computer simulation, Steel Beasts Pro™, in order to examine how well Swedish Army Doctrine has adapted to the available resources. The results show that a more defensive approach has a greater chance of achieving Sweden's operational and strategic goals. Finally, the study recommends changes that, if implemented, would adjust Swedish doctrine to its resources. The three recommendations are: 1. Re-evaluate the doctrinal statement that Sweden can only achieve decisive result in battle through offensive operations. 2. Change the statement that it is necessary for Sweden to achieve a decisive result in order to reach its operational and strategic goals; it is enough not to lose. 3. Include a description of the risks of the theoretical concepts used in the doctrine in order to get an increased understanding of the risk mitigation needed if these concepts are to be used with the current resources.					
<b>15. SUBJECT TERMS</b> Doctrine, Sweden, Army, Military Theory, Offense, Defense					
<b>16. SECURITY CLASSIFICATION OF:</b>			<b>17. LIMITATION OF ABSTRACT</b>	<b>18. NUMBER OF PAGES</b>	<b>19a. NAME OF RESPONSIBLE PERSON</b>
<b>a. REPORT</b>	<b>b. ABSTRACT</b>	<b>c. THIS PAGE</b>			<b>19b. PHONE NUMBER (include area code)</b>
(U)	(U)	(U)	(U)	123	

Standard Form 298 (Rev. 8-98)  
Prescribed by ANSI Std. Z39.18

MASTER OF MILITARY ART AND SCIENCE

THESIS APPROVAL PAGE

Name of Candidate: Major Magnus Frykvall

Thesis Title: Doctrinal Imbalance: A Study of Swedish Army Doctrine

Approved by:

\_\_\_\_\_, Thesis Committee Chair  
James J. Sterrett, Ph.D.

\_\_\_\_\_, Member  
Douglas E. Lathrop, M.A.

\_\_\_\_\_, Member  
Steven R. Scholtz, M.A.

Accepted this 13th day of June 2014 by:

\_\_\_\_\_, Director, Graduate Degree Programs  
Robert F. Baumann, Ph.D.

The opinions and conclusions expressed herein are those of the student author and do not necessarily represent the views of the U.S. Army Command and General Staff College or any other governmental agency. (References to this study should include the foregoing statement.)

## ABSTRACT

DOCTRINAL IMBALANCE: A STUDY OF SWEDISH ARMY DOCTRINE by Major Magnus Frykvall, 123 pages.

The Swedish Army has been significantly reduced during the last two decades. Despite the decreasing numbers of available forces, Swedish Army doctrine has remained essentially the same, built upon offensive concepts such as maneuver warfare and local superiority.

This study uses a combination of qualitative analysis using military theory, and quantitative analysis using a computer simulation, Steel Beasts Pro™, in order to examine how well Swedish Army Doctrine has adapted to the available resources. The results show that a more defensive approach has a greater chance of achieving Sweden's operational and strategic goals.

Finally, the study recommends changes that, if implemented, would adjust Swedish doctrine to its resources. The three recommendations are:

1. Re-evaluate the doctrinal statement that Sweden can only achieve decisive result in battle through offensive operations.
2. Change the statement that it is necessary for Sweden to achieve a decisive result in order to reach its operational and strategic goals; it is enough not to lose.
3. Include a description of the risks of the theoretical concepts used in the doctrine in order to get an increased understanding of the risk mitigation needed if these concepts are to be used with the current resources.

## ACKNOWLEDGMENTS

First, I would like to thank Dr. James Sterrett, Simulation Division, DLDC, CGSC, who from the very start of this study has helped me with resources and ideas that have proven to be vital for the results. Dr. Sterrett have also shown impressive patience with endless grammar and spelling corrections. Furthermore, Dr. Sterrett also involved his wife, military historian Dr. Corinne Mahaffey, and his father, retired English teacher Mr. Timothy Sterrett, who both provided valuable feedback.

Mr. Curt Pangracs, also from the Simulation Division, was a key person in building and handling the computer simulation part in the thesis. Without his patient and excellent work with Steel Beasts Pro™, the quantitative study in, Chapter 5, would have been impossible.

Mr. Doug Lathrop, DJIMO, has not only helped me with excellent language knowledge, but also as my initial point of contact, and the person who pointed me in the right direction during the initial phase of the study. Mr. Steve Scholtz, DTAC, played a vital part as a reader as well as a tactical advisor.

LTC. Peter Almström has been an absolutely necessary point of contact at the Swedish National Defense College (SNDC), both to provide vital source material and also to assure me that the study is relevant and had a valid focus. Dr. Håkan Gunneriusson, SNDC, gave me vital scientific direction, which increased the quality of the study.

MAJ Mats Wallden at the Swedish Land Warfare Center (LWC) was helpful in providing the terrain necessary for the computer simulation, and distributed draft versions of the thesis to LTC Ola Palmqvist and LTC Stefan Eriksson from LWC. These doctrinal

authorities, even though they do not agree with the conclusions of these study, provided valuable opinions on the doctrinal analysis conducted in Chapter 4,

Finally, this thesis would never have been done without the support and patience of my wife Jenny and my children Erik, Emma, and Elias – Thanks for your never-ending understanding.

## TABLE OF CONTENTS

	Page
MASTER OF MILITARY ART AND SCIENCE THESIS APPROVAL PAGE .....	iii
ABSTRACT.....	iv
ACKNOWLEDGMENTS .....	v
TABLE OF CONTENTS.....	vii
ACRONYMS.....	x
ILLUSTRATIONS .....	xii
TABLES .....	xiii
CHAPTER 1 INTRODUCTION .....	1
The Current Problem with Swedish Army Doctrine .....	4
The Research Question .....	6
Assumptions.....	7
Definitions .....	7
Limitations .....	9
Scope.....	9
Delimitations.....	10
Significance of this Study .....	11
Summary.....	11
CHAPTER 2 LITERATURE OVERVIEW .....	13
Chapter Outline.....	13
Related Research.....	13
Literature Overview .....	15
Problem-Framing Literature .....	16
Methodology Literature .....	18
Historical Literature .....	19
Simulation.....	19
Chapter Summary .....	19
CHAPTER 3 METHODOLOGY .....	20
Chapter Overview .....	20
General Description of Chosen Methodology .....	20
Introduction to the Case 9 Scenario .....	21

Qualitative Study .....	23
Quantitative Study Using Computer Simulation .....	24
Simulation .....	25
Choosing the Simulation Software .....	26
Research Ethics.....	29
Chapter Summary .....	32
CHAPTER 4 DOCTRINAL ANALYSIS .....	33
Chapter Overview .....	33
The Offensive Bias in Current Swedish Doctrine .....	34
The Offensive Bias in the Swedish Interpretation of Maneuver Warfare.....	35
The Offensive Bias in the Concept of Decisive Results .....	39
The Offensive Bias in Defensive Land Operations .....	40
Conducting the Doctrinal Swedish Offensive .....	41
Conducting the Doctrinal Swedish Offensive: Maneuver Warfare .....	42
Conducting the Doctrinal Swedish Offensive: Local Superiority .....	47
Testing Doctrine Using Case 9: Case 9 in Detail .....	50
Testing Doctrine Using Case 9: Applying Maneuver Warfare.....	51
Testing Doctrine Using Case 9: Applying Local Superiority .....	57
Is the Offensive the Only Route to Victory? .....	61
Chapter Summary .....	65
CHAPTER 5 SIMULATION RESULTS .....	66
Chapter Overview .....	66
Case 9.....	67
Orders of Battle.....	68
Blue Order of Battle.....	69
Red Order of Battle .....	70
Simulation Limitations and Workarounds .....	72
Simulation: The Swedish Army Uses Offensive Tactics.....	73
The Swedish Offensive: Results .....	77
Offensive Analysis.....	79
Simulation: The Swedish Army Uses Defensive Tactics .....	81
Defensive Analysis .....	87
Conclusions.....	89
CHAPTER 6 CONCLUSIONS, SUMMARY, AND RECOMMENDATIONS .....	93
Results.....	93
Further Research .....	94
Recommendations.....	94
APPENDIX A SWEDISH FORCES .....	98
APPENDIX B OPPONET’S FORCES .....	101



APPENDIX C SWEDISH COMMANDER'S INTENT .....	104
APPENDIX D SIMULATION DATA (DVD).....	107
BIBLIOGRAPHY .....	108

## ACRONYMS

AI	Artificial Intelligence
APFSDS-T	Armor Piercing Fen Stabilized Sabot – Tracer
AR 2013	Arme Reglemente Taktik 2013 [Army Tactical Regulations]
AT	Anti-Tank
BMP-3	Russian built IFV
BRDM	Russian built light armored recon vehicle
C2	Command and Control
Case 9	Krisfall 9 [Emergency Case Number 9] A fictional scenario used as strategic, operational and tactical framework for the study
CGSC	Command and General Staff College
COG	Center of Gravity
CSS	Combat Service Support
CV	Critical Vulnerability
DABL	Decisive Action Brigade Level
EU	European Union
ICM	Improved Conventional Munitions
IFV	Infantry Fighting Vehicle
LWC	Swedish Land Warfare Center
MBT	Main Battle Tank
MG	Machine Gun
MLRS	Multiple Launch Rocket System
MRSI	Multiple Rounds Simultaneous Impact
MSD 2012	Militärstrategisk Doktrin 2012 [Military Strategy Doctrine 2012]

MSR 2013	Markstridsreglemente 6 Bataljon Förhandsutgåva 2013 [Land Combat Regulation 6, Maneuver Battalion 2013]
NOFORN	Materiel and Data that is not to share with Foreigners
SAF	Swedish Armed Forces
SLOCS	Sea Lines Of Communications
SNDC	Swedish National Defense College
SPODS	Sea Points of Debarkation
SWE	Sweden

## ILLUSTRATIONS

	Page
Figure 1. Swedish Warfighting Model.....	3
Figure 2. Description of maneuver warfare.....	38
Figure 3. Relationship between Center of Gravity and Critical Vulnerability.....	43
Figure 4. How local superiority is achieved.....	48
Figure 5. Example of offensive land operations.....	61
Figure 6. Comparison of total loss ratios .....	67
Figure 7. Blue Order of Battle.....	70
Figure 8. Red Order of Battle.....	71
Figure 9. Mean MBT and IFV losses, offensive scenario.....	78
Figure 10. Mean infantry casualties for red and blue side, offensive scenario .....	79
Figure 11. Blue side task organization during the defense.....	82
Figure 12. Blue defensive deployment.....	83
Figure 13. Mean MBT and IFV losses, defensive scenario .....	86
Figure 14. Mean infantry casualties, defensive scenario.....	87
Figure 15. Loss ratio with mean, median, and 2 standard deviation intervals .....	91

## TABLES

	Page
Table 1. Results: Defensive Simulation.....	76
Table 2. Results: Defensive Simulation.....	85
Table 3. Total loss ratio in offensive and defensive simulations.....	90

## CHAPTER 1

### INTRODUCTION

#### Background

We can defend our nation against a limited attack with limited goals for approximately one week.<sup>1</sup>

— Swedish Supreme Commander Sverker Göransson, “*Försvar med tidsgräns*[Limited defense]”

Only by the means of an attack can a decisive result be achieved.<sup>2</sup>

— Swedish Army Tactical Regulations.

Sweden, as a neutral country, is not a member of any military alliance. Therefore, Sweden historically trusted in a relatively large military to guard against threats. Since 1980 however, the size of the Army has gradually shrunk, from 32 brigades in 1980 down to 2 in 2014.<sup>3</sup> Throughout this time, the core of Swedish Army doctrine<sup>4</sup> has not changed, calling for a counterattack to drive any invader back out of Sweden. This doctrine may have been feasible with the Army of 1980, but this study demonstrates that it is not feasible with the current Swedish Army. Sweden must either recapitalize its

---

<sup>1</sup>“Försvar med tidsgräns [ ],” *Svenska Dagbladet* [Swedish Daily Journal] 30 December 2012, [http://www.svd.se/nyheter/inrikes/forsvar-med-tidsgrans\\_7789308.svd](http://www.svd.se/nyheter/inrikes/forsvar-med-tidsgrans_7789308.svd) (accessed 11 November 2013).

<sup>2</sup>Försvarsmakten, *Arme reglemente Taktik (AT) 2013* [SAF, Tactical Army Regulation 2013] (Stockholm: Försvarsmakten, 2013), 46.

<sup>3</sup>Moreover, these 2 brigades are not at full strength due to a lack of personnel, and it is unknown when they will be at 100 percent strength.

<sup>4</sup>The US definition of doctrine diverges significantly from that used in Sweden. Because this study is written in the US, and the initial audience is American, the definition of doctrine in this work will be more American than Swedish. In this work, “Doctrine” is taken to mean military regulations.

Army to suit its doctrine, or change its doctrine to suit the Army it has. This lack of cohesion between resources and doctrine is one of the reasons of the provocative statement of the Swedish supreme commander.

The Swedish Army teaches that doctrine derives from a balance between resources, national will and national policy. There is an inherent logic in this statement: if a nation's military doctrine does not take into account its people's will and its resources, the nation risks defeat. The balance among these factors is comparable with Arthur F. Lykke's work about the importance of balance between ends, means, and ways in a national strategy. Lykke compares these different concepts to a three-legged chair and claims that the three legs - the ends (peoples' will), the ways (military doctrine), and the means (military resources) - have to be equally long if the chair (the overall national strategy) is to be useful. If the end state is too ambitious and one leg is too long, the chair will be hard to use. Equally, if the means provided are insufficient to deliver the intended ends through the specified ways, the national goals cannot be accomplished.<sup>5</sup>

In the case of an imbalance within the pillars that constructs the warfighting capability, there is a risk that soldiers' and commanders' training prepares them to fight in a way that is neither realistic nor feasible. There is also a risk that the doctrine is perceived to be unrealistic, both within the Army and by external audiences, inviting reduced morale internally and potential aggression externally.

When presenting this problem to American colleagues, most of them perceived the problem as a "no-brainer." Given the Swedish operational and strategic situation,

---

<sup>5</sup>Arthur F. Lykke Jr., ed., "Military Strategy: Theory and Application" (Research Paper US Army War College, Carlisle, PA, 1998).

combined with its limited resources, a defensive doctrine seemed obvious to them. However, a problem often seem simpler to outsiders who have no investments in its solution. In Sweden, the tactical culture prescribes maneuver warfare and importance of a decisive result on the battlefield. The study will have its primary impact within the Swedish Army; however; the combined methodology used in the study is generic.



Figure 1. Swedish Warfighting Model

*Source:* Försvarsmakten, *Dmarko2002* [Swedish Defense Force, Doctrine for land operations 2002] (Stockholm: Försvarsmakten, 2002), 2.



## The Current Problem with Swedish Army Doctrine

On the tactical level, current Swedish army doctrine is obsolete because the Army's size no longer matches the tasks that doctrine assigns to the force, the three pillars that constitutes the warfighting capability is not in balance. If Sweden's resources were unlimited, it would be possible to adjust its military capabilities to its doctrine. However, resources are limited. Economic factors play a key role in the process of developing and maintaining Swedish military forces. If military forces adapt to economic factors, but doctrine does not, imbalance will occur. The fact that the Swedish Army shrank from 32 army brigades to 2 during the last 30 years suggests that either the mission or the doctrine should be changed, or both. Since the Army does not choose its mission (to defend Sweden), and there is no sign of significantly increased resources for the Swedish Armed Forces (SAF), the only alternative is to adapt the doctrine to the current mission and available resources. As this study will demonstrate, if the doctrine does not change, the Swedish Army may not even be able to meet the Supreme Commander's statement that the Swedish Armed Forces only can defend Sweden in one defined area for one week<sup>6</sup> once the 2018 changes are in place.

It is vital to point out that Swedish Army tactical doctrine has changed multiple times during the last 30 years. However, these changes have not resulted in a doctrine that is balanced with available resources. Swedish doctrine still emphasizes an offensive way of warfighting, just as it did when 32 brigades were at the supreme commander's disposal. The current doctrine bases its argument on the concept of "local superiority". The concept of local superiority demands massed forces, freedom of action, and tactical

---

<sup>6</sup>Svenska Dagbladet, "Försvar med tidsgräns."

surprise in order to succeed. However, it is difficult to achieve freedom of action, massed force, and surprise when employing two brigades against an opponent with five to six brigades.<sup>7</sup>

In Swedish doctrine, the local superiority scenario supposes that the Swedish Army's two brigades are fighting one opposing brigade. However, an attack against Sweden with only one brigade is unrealistic, and Sweden only has two brigades. The doctrinal scenario does not specify whether the opponent only has one brigade in the country, or whether some other forces are engaging the other invading forces. The scenario provided thus appears to commit the entire Swedish Army against a portion of the invading force without ensuring that the remainder of the invading force is somehow pinned. Thus, the scenario is of limited value in answering questions of how to achieve local superiority. Furthermore, it implies accepting significant risk if the two brigades suffer heavy losses, as Sweden would have massed its units but held no qualified maneuver units in reserve.

It is a common tenet of military theory, and of Swedish doctrine, that the defense is stronger than the offense.<sup>8</sup> However, Swedish doctrine also states: “only by attacking can a decisive result be achieved,”<sup>9</sup> and “defensive operations should only be conducted in order to gain time to enable subsequent offensive operations.”<sup>10</sup> Given that the

---

<sup>7</sup>Case 9, Swedish National Defense College Appendix C.

<sup>8</sup>Carl von Clausewitz. *On War*, ed. and trans. by Michael Howard and Peter Paret (Princeton, NJ: Princeton University Press, 1984), 360.

<sup>9</sup>Försvarsmakten, *Arme reglemente Taktik 2013* [SAF, Tactical Army Regulation 2013] (Stockholm: Försvarsmakten, 2013), 46.

<sup>10</sup>*Ibid.*

Swedish Army consists of two maneuver brigades, the risks involved in committing the entire Army into a single battle makes Swedish tactical doctrine too offensive. It has not been adapted to the significant downsizing of the Swedish Armed Forces that occurred during the last twenty years.

### The Research Question

This research began with the following question:

If Swedish Army tactical doctrine were changed to focus on defense instead of offense, would the current two-brigade structure be more likely to meet Sweden's strategic goals?

This main question contains three sub-questions, which are doctrinal in nature and challenge core assumptions in Swedish doctrine. These are:

1. Are offensive operations the only means of achieving decisive victory?
2. Must the Swedish Army reach a decisive victory in order to achieve national strategic goals in the given scenario?
3. Would a shift from offensive to defensive operations produce the desired strategic goals?

The third question is to be examined through computer simulation, asking two further questions:

4. What is the loss ratio between blue and red units when offensive tactics are used?
5. What is the loss ratio between blue and red units when defensive tactics are used?

## Assumptions

The strategic and tactical framework for the study is the Case 9 scenario used by the Swedish National Defense College (SNDC), which is an unclassified version of a scenario used by the Swedish armed forces headquarters. This study assumes that Case 9 is a valid proxy for Sweden's strategic, operational, and tactical situation. In the Case 9 scenario, two brigade's worth of air assault and naval infantry forces attack Sweden. These assault forces seize and open two ports, enabling the entry of four heavy maneuver brigades, which then attempt to seize Stockholm. Case 9 is described in detail in chapter 3, and elsewhere as needed.

This study assumes that the Swedish Army is not going to field more than two brigades during the upcoming decade.

## Definitions

In order to avoid biases and fallacies due to different definitions of key concepts, the definitions used in the study derive from the very same Swedish doctrinal documents under discussion. These are the primary doctrinal documents used in the study:

Arme' Reglemente Taktik 2013 [Army Tactical Regulations (2013)]

Markstridsreglemente 6 Bataljon Förhandsutgåva 2013 [Land Combat Regulation 6, Maneuver Battalion (2013)]

Offensive operations: Offensive operations goals are to seize and exploit the initiative or reach a decisive result according to a plan. Only through offensive action can a decisive victory be achieved.<sup>11</sup>

---

<sup>11</sup>Försvarsmakten, *Arme reglemente Taktik 2013*, 46.

Attack: Attack is a highly mobile and offensive way of warfighting, conducted by the use of fires and maneuver into an area currently held by the opponent.<sup>12</sup>

Defensive operations: Defensive operations aim to stop conditions from deteriorating, or to create favorable conditions for offensive operations.<sup>13</sup>

Defense: A defense is conducted with available weapons systems from strongpoints or combat positions, with support from engineering assets and indirect fires.<sup>14</sup>

Doctrine: The US definition of doctrine diverges significantly from that used in Sweden. Because this study produced in the US, and the initial audience is American, the definition of doctrine in this work will be more American than Swedish. In this work, “Doctrine” is taken to mean generic military regulations on all the levels of warfare but not detailed checklists and procedures. This definition includes regulations down to battalion level. The Swedish doctrinal documents used in this study can be compared with us doctrinal documents on ADRP level.

Maneuver warfare: Maneuver warfare enables an inferior force to defeat a superior force, achieving decisive results by exposing the opponent to systemic shock. It uses maneuver and fires at a high tempo, seizing the initiative from the opponent and

---

<sup>12</sup>Försvarsmakten, Markstridsreglemente 6.Bataljon, *R FM MSR 6 Manöverbat FU* [SAF, Regulation for Land Warfare 6 Maneuver Battalions] (Stockholm: Försvarsmakten, 2013), 49.

<sup>13</sup>Försvarsmakten, *Arme reglemente Taktik 2013*, 46.

<sup>14</sup>Försvarsmakten, *R FM MSR 6 Manöverbat FU*, 96.

disrupting the opponent's ability to react. This disruption leads to a systemic breakdown of the opponent's ability to fight effectively.<sup>15</sup>

### Limitations

It is vital that this study remains unclassified in order to keep it available to both Swedish and American audiences. Therefore, only unclassified data is used in this study, which lowers the level of realism in certain technical aspects of the simulation such as detailed effects of weapon and protection systems.

The doctrinal documents being analyzed were written in Swedish and some concepts could be interpreted in different ways. Unless otherwise stated, all translations are the author's. Where there are differing opinions regarding interpretation of a concept, the different interpretations will be explained.

The computer simulation used, Steel Beasts Pro™, has certain limitations, but was the best fit for the project. These limitations, and the primary alternatives, will be discussed in detail in Chapter 3.

### Scope

This study, written in 2014, examines current Swedish doctrine and regulations written in 2012 and 2013. The doctrine prior to the current one is from 2002 and was not replaced for ten years, which makes it logical to assume this doctrine will remain valid for the next 5-10 years.

The strategic and tactical framework for the study is the scenario Case 9, used by the Swedish National Defense College (SNDC), which is an unclassified version of a

---

<sup>15</sup>Försvarsmakten, *Arme reglemente Taktik 2013*, 32.

scenario used by the Swedish HQ. The scenario includes a strategic attack against Sweden's capital by a peer opponent with the goal of achieving geographical gains around the Baltic Sea. It also includes blue and red organizations that are used in the simulation as well as in this paper's doctrinal analysis. A more detailed description of the scenario is located in Chapter 3.

### Delimitations

In order to have a foundation for the logical arguments in this study, there must be a strategic and tactical framework. This study uses the Case 9 scenario and does not consider alternate strategic situations.

Only ground forces will be simulated in the experiment because Army doctrine is being examined, not air or naval doctrine. The Swedish Army does not have any organic attack aviation resources; furthermore, direct support to ground units from the Swedish Air Force is nonexistent in the Case 9 scenario, and is assumed not present for the red side either.

Swedish Home Guard units will not be discussed in the study. Due to their limited capability for operational movement, and their limited maneuver and firepower capabilities, they are not expected to undertake operations against opposing heavy units. According to Case 9, two battalion-sized Home Guard units are operating in the area, mainly engaging air assault units. Since this study focuses on operations against opposing mechanized formations, the Home Guard units will be ignored.

### Significance of this Study

Given current constraints and scarce resources, combined with recent events in Ukraine, both the Swedish military and Swedish society want to make sure that the nation gets the most out of the taxpayers' money. Efficient use of available military units is vital in order to effectively defend the nation. The foundation for the efficient use of military units is a doctrine that is adapted to both the strategic goals and to the available resources.

This study will point out deficiencies in the current Swedish doctrine. The key deficiency is that military doctrine is too offensive in relation to the force structure. It will propose changes to the doctrine that will hopefully sparks an active debate and continuous analysis of the Swedish doctrine. On a long-term basis, this can lead to a more efficient use of the Swedish Army's units, which can then better contain the advance of an aggressor. This, in turn, buys time, which can be used to enable military help from international actors. Another effect of this could be that the Swedish commanders and soldiers train to fight efficiently with the army they have, not the one they once had, or the one they wish they had.

### Summary

The Swedish Army doctrine states that offensive warfighting is the only way to achieve Sweden's operational and strategic goals. It has not adapted to the fact that Sweden has less than two brigades at its disposal. This study will provide a deeper understanding of the current imbalance between offensive and defensive warfighting as well as provide proposals for doctrinal changes. The ultimate goal of the study is to increase Swedish warfighting capability without creating a need for additional resources.



Chapter 1 has set out the framework for the study, defined key concepts, identified weaknesses and possible risks, and set out the scope and limits. Chapter 2 discusses the different sources used in the study, as well as previous research in the area of doctrinal balance. Chapter 3 explains the methods used in the study, first the qualitative method used in chapter 4, and then the quantitative method used in chapter 5, as well as the selection process for the simulation software. It also reports the techniques used to apply a high level of research ethics to the study. Chapter 4 starts with a discussion about why the author thinks there is a significant bias in favor of offensive operations and tactics in the Swedish Army Doctrine and continues with a description of how these tactics are supposed to be carried out. The doctrinal correct tactics are applied within the Case 9 scenario and then analyzed. At the end of Chapter 4, the question of whether offensive tactics is the only way to achieve Sweden's strategic goals is discussed. Chapter 5 initially gives the strategic, operational and tactical frameworks that are used in the simulation, followed by the results and analysis of the simulations; first, when blue side uses offensive tactics, and then when blue side uses defensive tactics. The differences in the simulation runs are discussed and the chapter sums up with conclusions. Chapter 6 summarizes the results from chapters 4 and 5 and uses these results to form conclusions and proposals for doctrinal change. Chapter 6 also notes questions for further research.

## CHAPTER 2

### LITERATURE OVERVIEW

#### Chapter Outline

No previous research examining the balance between doctrine and military power has been found, either in the USA or in Sweden. However, some research has been conducted at Swedish National Defense College (SNDC) that is related to the Swedish warfighting model with its moral, conceptual and physical factors. Research was also conducted at SNDC with the aim of examining why a nation's military doctrine is formed a certain way, and how a doctrine is created. This chapter begins with a brief overview of this research, followed by a broad overview of the other types of literature used in this study. Finally, there is a brief explanation of the software used in the experimental part of the study.

#### Related Research

Barry R. Posen's seminal work *The Sources of Military Doctrine: France, Britain and Germany between the World Wars*<sup>16</sup>, uses balance of power theory, organization theory, geographical factors, and technology level, in order to examine causal connections among German, British and French interwar doctrines. Posen tries to answer why a nation's military doctrine is constructed in a certain way. His model might be useful in explaining why there is imbalance or balance in a national military doctrine.

---

<sup>16</sup>Barry R. Posen, *The Sources of Military Doctrine: France Britain and Germany between the World Wars* (Ithaca, NY: Cornell University Press, 1984).

However, he does not incorporate the composition and size of each nation's military in the calculation, which is the focus for this study.<sup>17</sup>

One relevant conclusion of Posen's study is that in times of low tension the military establishment tends to act in isolation from its political masters, which can lead to a disparity between a nation's military doctrine and its overall national strategy. Sweden has not fought a war since 1814, which means the current Swedish doctrine is untested. Furthermore, the Swedish military and political establishment has rated the military threat directed against Sweden as minor for the last 20 years. According to Posen, these factors increase the risk that Swedish military doctrine diverges from the national policy. If so, this could partly explain Sweden's doctrinal imbalance.<sup>18</sup>

Rebecka Haendler examines whether the Swedish 3-pillar warfighting model has validity in more recognized international military theory. By conducting a qualitative analysis of the Swedish pillar model using David Galula's theory of counter insurgency and John Warden's air power theory as a tool, she concludes that the model is valid. She also demonstrates that there is both a strong connection among the three different pillars and that they influence each other. Although Handler's research has a different purpose from this study, she mentions that the three pillars "have to be adapted to each other."<sup>19</sup> In other words, she concludes that there has to be a balance among the three pillars.

---

<sup>17</sup>Ibid.

<sup>18</sup>Ibid., 241.

<sup>19</sup>Rebecka Haendler, "Krigföringsförmåga: Svensk doktrin och dess stöd i internationella teorier [Warfighting capability: Swedish Doctrine and its Correlation with International Theory's]" (Bachelor's thesis, SNDC, Stockholm, 2012), <http://fhs.diva-portal.org/smash/record.jsf?searchId=1&pid=diva2:536773> (accessed 16 January 2014).

There are many other theses and monographs conducted on Swedish doctrine at SNDC. However, they are focused on research within one of the warfighting pillars, not the interaction between the pillars, nor whether they are adapted to each other. Some evaluate Swedish doctrine using recent international operations where the Swedish Army been deployed, or historical battles with other nations' armies. Furthermore, some interesting work concerns Swedish doctrine and how it was created, as well as possible flaws in that process. These works are undoubtedly of great value when it comes to writing a new doctrine, but none of them evaluates doctrine against a specific scenario using the actual forces the doctrine is supposed to guide.

Significant research has been conducted within the conceptual pillar but there seems to be a lack of research about the connections between a conceptual part and the physical part of a doctrine. In particular, there is no research evaluating the doctrinal concepts against a concrete scenario using the actual forces the concepts are supposed to guide.

This study begins to fill the gap in this area of research.

### Literature Overview

The literature used in the study falls in to three broad categories. Problem-framing literature, methodology literature, and historical literature.

Problem-framing literature defines the problem and key concepts related to the doctrinal imbalance. It is also the main source used to clarify, to analyze doctrinal weaknesses, and to explain the possible negative effects of these weaknesses.

Methodology literature consists of books, regulations and pamphlets regarding the use of computer simulations when conducting operations research. It is used as a tool to

ensure quality while conducting the simulations. It also ensures that data from the simulations is interpreted correctly and that the results are presented in an understandable and easily accessible matter.

Military theory used in the analysis of the problem-framing literature is also a part of the methodology literature. It mainly consists of seminal works from recognized military thinkers, both in the USA and Europe.

Historical literature is used to explain and enhance the analysis as well as providing examples to clarify certain points. Historical literature used in the study consists of case studies, and although they are secondary sources, they provide valuable examples in order to enhance the level of understanding for the problem and its possible solution.

In order to keep the study unclassified, only unclassified sources are used. An unclassified study is necessary in order to enable free distribution. Furthermore, remaining unclassified is vital in order to use a computer simulation model in a foreign school environment.

The next selection criterion is significance, which strives to find the most valid, relevant and knowledgeable literature in each purpose area.

Finally, use of primary sources is maximized. If a primary source is available, it has been used in preference to a secondary source in order to decrease risk of biases and other deficiencies.

### Problem-Framing Literature

The main problem-framing documents are Swedish doctrinal manuals. Although there is only one doctrine, there are numerous sub-documents to it. Since this study

discusses issues on the tactical level, these sub-doctrinal documents are crucial to conduct the analysis in chapter 4. The three main sources are:

*Militärstrategisk doktrin 2012* [Military Strategy Doctrine (2012)]:<sup>20</sup> according to the preface, this document's purpose is to guide the analysis, planning, execution and evaluation of military operations conducted by the Swedish Armed Forces. It shall also be used as a reference before decisions are made at the tactical, operational and strategic level.<sup>21</sup>

Although Military Strategy Doctrine (MSD) mainly describes levels above the tactical level examined in this study, it is used to increase the understanding of the sub-doctrinal documents that are examined. It also puts these documents in a strategic framework, which is necessary in order to connect tactical arguments to operational and strategic results.

*Arme reglemente Taktik 2013* [Army Tactical Regulations (2013)]<sup>22</sup>: derived from the Swedish doctrine, the Army Tactical Regulations (AR) provide the foundation for the tactical application of ground forces. It also directs education and training in the areas of tactics and leadership within the Army. Furthermore, it gives directions for war planning

---

<sup>20</sup>Försvarsmakten, *Militärstrategisk doktrin (MSD) 2012* [Military Strategy Doctrine 2012] (Stockholm: Försvarsmakten, 2011). Note that the concept of military strategy does not exist in USA, however, it is the highest military level, and the level that makes sure that the military tool solves the political goal. It has the same meaning as “strategy” in the US.

<sup>21</sup>Försvarsmakten, *MSD 2012*, 11.

<sup>22</sup>Försvarsmakten, *Arme reglemente Taktik 2013*.

as well as tactical and technical procedures within the different branches. It is applicable to both national and international operations and is to be used in all levels of intensity.<sup>23</sup>

*Markstridsreglemente 6 Bataljon Förhandsutgåva 2013* [Land Combat Regulation 6, Maneuver Battalion (2013)]:<sup>24</sup> the document is on a level just below the Tactical Regulations for the Army (AR) and gives more detailed regulations about the use of Swedish battalion level units in land operations. It is to be used together with AR and the Military Strategic Doctrine (MSD) and its main audience is battalion commanders and staff members as well as military students.<sup>25</sup> Although it is pre-release, it is finalized from a doctrinal perspective, as only layout issues and pictures are to be changed in the final version.<sup>26</sup> It is vital to use the latest doctrinal documents, even though they are not finalized, since the study looks into the future.

#### Methodology Literature

*Militärteorins grunder* [The Foundations of Military Theory]<sup>27</sup>

This book is a comprehensive compilation on military theory, focused on those military thoughts that have proven themselves universal and valid regardless of time, space, culture or technology. Furthermore, it mainly discusses military theory that is valid for Swedish doctrine, which makes it relevant to use in this study. The Foundations of

---

<sup>23</sup>Försvarsmakten, *Arme reglemente Taktik 2013*, 9.

<sup>24</sup>Försvarsmakten, *MSR 6 FU*.

<sup>25</sup>Försvarsmakten, *MSD*, 5.

<sup>26</sup>*Ibid.*, 4.

<sup>27</sup>Jerker Widen and Jan Ångström, *Militärteorins Grunder* [The Foundations of Military Theory] (Stockholm: Försvarsmakten, 2004).

Military Theory (FMT) has been used as a reference tool in order to find relevant theories for each of the different concepts that are to be analyzed in chapter 4.

## Historical Literature

### Simulation

*Steel Beasts Professional*<sup>TM</sup> is an unclassified commercial vehicle-centric simulation tool used by the Swedish Army. It is used to train vehicle crews and units from individual level (commander and gunner) to battalion level combined arms tactical training and brigade level exercises without troops. Steel Beasts Pro<sup>TM</sup> has “An elevated level of fidelity modeled in direct fire exterior and terminal ballistics, fire control systems and related crew procedures as well as the relationship between complementary elements of combatants in the tactical spectrum.”<sup>28</sup> The reasons for choosing Steel Beasts Pro<sup>TM</sup>, and its strengths and weaknesses, is reported in chapter 3.

### Chapter Summary

The relation and interdependency between the conceptual and the physical factors within Swedish warfighting capabilities is an area where there is limited unclassified knowledge. Although there are multiple sources that state that there has to be a balance within a doctrine, no work tries to measure whether a doctrine is in balance or not. This study aims to analyze Swedish Army tactical doctrine in order to determine if the Swedish Army is using its forces in the most efficient way.

---

<sup>28</sup>Quoted from eSims’ webpage description of Steel Beasts Pro<sup>TM</sup>. [https://www.esimgames.com/?page\\_id=823](https://www.esimgames.com/?page_id=823) (accessed 18 January 2014).



## CHAPTER 3

### METHODOLOGY

#### Chapter Overview

Measuring the efficiency of a nation's doctrine without waging war is challenging. There are numerous reasons for this. For example, a nation's doctrine could be used as a political instrument rather than as pure military guidance. It could also be sensitive from a security point of view, and it can be hard or even impossible for researchers to get access to all the necessary information, though this was not a significant hurdle for this study.

This work examines the question of whether Swedish tactical army doctrine strikes an efficient balance between offensive and defensive warfighting, given its current resources, in the context of the Case 9 scenario, by using both qualitative and quantitative analyses. This chapter explains the methodology used. First, the Case 9 scenario is introduced, followed by an explanation of the qualitative doctrinal analysis, and then issues of quantitative simulation selection and utilization. At the end of the chapter, research ethics and validity considerations are discussed.

#### General Description of Chosen Methodology

A combination of two research methods is used: First, a qualitative case study is used to examine whether the Swedish Army tactical doctrine has a balance between offensive and defensive operations, within the given framework of Case 9.<sup>29</sup> The

---

<sup>29</sup>Sharan B. Meriam, *Qualitative Research: A Guide to Design and Implementation* (San Francisco: John Wiley and Sons, 2009), Chapter 3.

doctrine is analyzed in the context of the same military theory that was used to create the doctrine. Second, a quantitative computer-based simulation method is used in order to test the results from the qualitative study. The results of both analyses are then used in order to support proposed changes to the tactical army doctrine regarding offensive and defensive operations that are likely to increase warfighting efficiency in a scenario similar to Case 9.

### Introduction to the Case 9 Scenario

The Case 9 scenario assumes that, as in reality, Sweden has been neutral since 1914 and is not a member in any military alliance. It is a member of the European Union (EU) as well as United Nations (UN), and NATO's Partnership for Peace program (PfP), and has officially stated that it is prepared to help other EU states in case of emergency.

However, the scenario assumes that there has been a deteriorating security situation in the Baltic Sea Area since 2014, and by 2019, the relationship among some of the states surrounding the Baltic Sea is extremely tense. In April 2019, one of the states makes territorial claims on some key Swedish terrain in the Baltic Sea. When Sweden rejects these claims, the opponent launches a strategic attack against the capital region of Sweden. The attack begins with three battalion-sized air assaults around key airfields and bridges north and south of Stockholm and a brigade-sized naval infantry attack against two harbors east of the capital. The Swedish Navy and Air Force do not succeed in stopping the opponent from establishing a sea line of communication (SLOC) including two sea points of debarkation (SPODs) near the capital. Once the SPODs are established, the initial marine attack is reinforced by four mechanized brigades within three days.

The operational aim of the opponent is to seize the Swedish capital of Stockholm as quickly as possible in order to gain their strategic goals.

The Swedish strategic goal is to maintain sovereignty and recover the favorable security situation that existed before the invasion. A key assumption is that the Swedish armed forces must defend Sweden by themselves for 8 to 14 days. After that, either international pressure will put a halt to the aggression, or Sweden will get military help from the European Union or other friendly forces.

As mentioned in Chapter 2, the scenario is unclassified and is used by SNDC in its operational art course, which is part of the mandatory curriculum for postgraduate staff education at SNDC. This makes the scenario familiar both to the author and to the Swedish part of the audience for this study. Furthermore, the scenario is an unclassified version of one of the scenarios used in war-gaming exercises within the Swedish HQ, which increases its validity as a case given the purpose of the study.

In the doctrinal documents, there are examples of how the Swedish forces are to apply the doctrine in combat. In these examples, the opponent is inferior in numbers. However, it is extremely implausible that an opponent will attack with only a single brigade, instead of massing the combat power necessary to achieve victory. Given the common wisdom that a 3:1 force ratio is necessary when attacking, it seems reasonable to expect that the opponents will deploy the 5 or 6 brigades seen in Case 9<sup>30</sup>. It seems risky to build Army doctrine on the assumption that the Navy and the Air Force will eliminate at least 80 percent of the enemy strength on their own. Logically it would be better to create a doctrine for the worst case, and adapt to a more favorable situation if it arises,

---

<sup>30</sup>Widen and Ångström, 181.

instead of being forced to adapt to an unfavorable situation during an ongoing conflict. In short, “train hard, fight easy” is more efficient than the opposite. It is therefore valid to measure the doctrine against Case 9 instead of against the examples provided in doctrine.

### Qualitative Study

Although a traditional case study normally includes a defined case that has actually happened, it could also be a qualitative examination of an idea or an object.<sup>31</sup> In this case, the “object” is the doctrinal documents that are being studied, in the context of a particular situation, Case 9, which makes it a particularistic case study.<sup>32</sup> It is also partly heuristic because the case study will increase the reader’s understanding of the problem and clarify relationships and phenomena within the area of tactical doctrine.<sup>33</sup>

The samples used in the study are the three doctrinal and sub-doctrinal documents described in the previous chapter. These documents are the only ones currently providing tactical guidance at the level of battalion and above. Together, they give a comprehensive compilation of current Swedish doctrine, from the strategic to the tactical level. The fact that none of the documents is older than three years increases the validity of those documents because Sweden typically changes doctrine roughly every ten years, and thus these documents are unlikely to be replaced in the near future. Data collection from these documents is conducted by text analysis from the perspective of offensive and defensive warfighting. The balance between offensive and defensive warfighting is used in order to

---

<sup>31</sup>Merriam, 41.

<sup>32</sup>Ibid., 43.

<sup>33</sup>Ibid., 44.

measure whether the Swedish doctrine utilizes its maneuver units in an efficient way within the framework of Case 9.

The selected data from the doctrinal documents were analyzed using military theory as the analytical tool. In order to make sure that the analytical tool is correctly matched to the research object, this study analyzes doctrine using the very same theory that was used to write the doctrine.<sup>34</sup> The analysis also works to clarify inherent relationships between military theory and Swedish doctrine.

### Quantitative Study Using Computer Simulation

The quantitative research was conducted with a computer simulation. This method was the most feasible quantitative tool in comparison with other alternatives. Full-scale exercises were ruled out due to resource reasons and a historical case study could not be examined within the same strategic framework (Case 9) as the qualitative part of the study. Pure statistical analysis was ruled out due to the difficulty of taking factors such as terrain into account, and the danger of burying too many assumptions in any spreadsheet model that would then predetermine the outcome. The phenomenon that is being simulated, combat, also fits well with computer simulation according to Jerry Bank's (et al.) seminal work about discrete event simulation where he states:

“Simulations enable the study of, and experimentation with, the internal interactions of a complex system or of a subsystem within a complex system” .... “New policies, operating procedure, decision rules, information flows, organizational procedures, can be explored without disrupting ongoing operations of the real system.”<sup>35</sup>

---

<sup>34</sup>Widen and Ångström, Preface by Chief of Staff.

<sup>35</sup>Jerry Banks, John S. Carson II, Barry L. Nelson, and David M. Nicol, *Discrete-Event System Simulation*, 5th ed. (New Jersey: Pearson Education, 2010), 4f.

These different factors combined lead to the conclusion that a computer simulation was the most suitable quantitative tool to validate the results from chapter 4.

### Simulation

The purpose of the simulation is to compare two different ways of conducting tactical warfighting for the Swedish Army. It is simulated at the battalion level for the Swedish Army (blue side) and brigade level for the opponent's ground units (red side), in the same sort of terrain as in the scenario from the SPOD to the capital. Both the blue and red sides are directly transferred from Case 9. The event simulated is a decisive tactical battle within the framework of Case 9.

In both cases, the red side is attacking with a mechanized brigade, while the blue side is delaying in one of the cases and attacking in the other. The blue side, in both cases, fights according to doctrine and in the depth and width stated in the doctrine.<sup>36</sup> The red side attacks along the outgoing roads from the SPOD in the red organizational structure, which in Case 9 is a brigade structure. The red side is kept at brigade strength because the blue battalion is numerically stronger than an individual red battalion. In both cases, the red side uses the same attack plan. Due to the terrain, neither the blue nor the red units are able to mass forces larger than company size during the attack. This is why the battalion level attack on the blue side was sufficient in order to compare the two different events, and has the additional virtue of keeping the forces in the two scenarios identical – only the blue plan is changed.

---

<sup>36</sup>Försvarsmakten, *MSR 6 FU*, Chapter 6.

In each case, 20 simulations were run and data about red and blue losses were collected in order to provide data to analyze loss ratios. According to Dan Eastwood 20 runs has predictive power, given the expected difference between the simulations of approximately 1:3.<sup>37</sup>

The data will be reported in Chapter 5, together with the analysis, in order to answer the two supporting questions in the study about red and blue losses in the two different cases. The answers to those questions can confirm or refute the results from the qualitative study as to whether or not the Swedish tactical doctrine utilizes its forces the most efficient way.

#### Choosing the Simulation Software

The purpose of the simulations was to compare two different ways of fighting. Minor deviations from reality will not affect the result as long as they are consistent in both events and similar for both sides. Alternatively, as Banks (et.al.) puts it:

“[The goal of validation is] to produce a model that represents true system behavior closely enough for the model to be used as a substitute for the actual system for the purpose of experimenting with the system.”<sup>38</sup>

In order to enable the comparison, there are certain criteria that need to be fulfilled. The most important ones were to conduct multiple runs with minimal human intervention, to simulate tactical fighting in terrain and with units that are accurate to Case 9, and to build the scenario and conduct the runs within a feasible amount of time.

---

<sup>37</sup>Mr. Dan Eastwood, Email correspondence with author.

<sup>38</sup>Banks et al., 388.

Furthermore, the simulation software had to be available at the U.S. Army Command & General Staff College.

Considering these facts, the Simulations Division (Digital Leader Development Center, U.S. Army Command & General Staff College) recommended close consideration of three different simulations: OneSAF, which is the U.S. Army's official research simulation tool, Decisive Action Brigade Level (DABL), a simulation tool used for brigade staff exercises at CGSC, and Steel Beasts Pro™, which is a commercial vehicle-centric simulation tool for PCs used by the Swedish Army.

OneSAF, even though it is the only software of the three that is programmed with the purpose of conducting research, was ruled out at an early stage. It does not have databases of Swedish units or terrain, which would be quite time-consuming to create. This problem could be overcome in theory. However, after asking the OneSAF program manager about the possibility of assistance with using the program in the study, the reply was that OneSAF is not cleared for use by non-US nationals. The OneSAF program manager sought an exception in this case, but was unable to gain one, which put an end to consideration of OneSAF.

DABL is an unclassified program used for staff training at CGSC and parts of the Captain's Career Course. While it does not have the correct Swedish units or the valid terrain, these are simple to create in DABL. The software is also easy to operate. However, the software has too little detail for the study. Moreover, its outcomes are highly deterministic, so there would be very little variation between simulation runs using the same plan. It also demands a significant degree of human intervention, which makes the simulation more time consuming and introduces a greater threat of intentional or



accidental bias. DABL was not created for conducting research and has not been used in similar research.

Steel Beasts Pro™ is an unclassified vehicle-level tactical simulation. Like DABL, it was neither designed for, nor previously used in, research studies. However, because Steel Beasts Pro™ is used by the Swedish Army, it already has the necessary Swedish units, and authentic, detailed terrain was provided by the Swedish Land Warfare Center (LWC). It also includes red and blue organizations and units, which could be adapted to Case 9 within the timeframe for this study. Its use in Sweden by the LWC enables continued research or validation of the research conducted in the study. Steel Beasts Pro™ also supports multiple runs with very limited human intervention when executing preset plans. However, building these scenarios required significant effort, and Mr. Curt Pangracs of the Simulation Division spent more than two months to create, troubleshoot and run the scenarios. Once a plan is built, the software enables the outcome to vary significantly because the results of individual actions – hit or miss, penetrate or not, damage inflicted, and the simulated vehicle commanders’ use of terrain – all produce significant variation in scenario outcomes without human intervention, which makes the results statistically useful.

A further strength of the software, which was not known until the simulation runs started, is that some behavior by the artificial intelligence simulated battlefield friction well.<sup>39</sup> This includes vehicles becoming stuck in ditches, subordinates getting lost when they lose contact with their superiors, and traffic jams in chokepoints. The scope and frequency of these outcomes matched the author’s experience with mechanized forces in

---

<sup>39</sup>Clausewitz, Chapter 1; Försvarmakten, *Arme reglemente Taktik 2013*,10.

similar terrain in Sweden. Overall, Steel Beasts Pro™ was the most suitable simulation and fulfilled the high expectations put on it at the beginning of this research.

### Research Ethics

A high level of research ethics is vital in order to achieve acceptable reliability and validity.<sup>40</sup> Merriam's eight different strategies for promoting validity have been used in order to reach that goal in this study.<sup>41</sup> Below follows a short description of each of these strategies as well as examples of how it has been applied in the study.

Triangulation: using multiple examinations or sources in order to confirm results of the study.<sup>42</sup> This is applied by using different research methods: both a qualitative case study and a quantitative computer simulation. It is also used within the case study by using three different doctrinal documents which decreases the risk that any doctrinal concept is misinterpreted.

Member checks: taking data and interpretations back to the original source to check if they are plausible.<sup>43</sup> It is hard to achieve this with the doctrinal documents because they do not have any specified authors. However, draft versions of the study were submitted to LTC Peter Almström, SNDC, who was in the working group for *Army Tactical Regulations*, LTC Mats Eriksson and MAJ Mats Wallden, Land Warfare Center (LWC) who has great knowledge about the Swedish army Doctrine. These individuals

---

<sup>40</sup>Merriam, 228.

<sup>41</sup>Ibid., table 229.

<sup>42</sup>Ibid., table 9.1

<sup>43</sup>Ibid.

checked the analysis of the doctrinal documents and their opinions are reported when they divagate from that of the authors. For the quantitative part, a professional statistician, Mr. Dan Eastwood, provided support in order to ensure a scientifically correct interpretation of the simulation data. Furthermore, a CGSC tactics instructor, Mr. Steve Scholtz, checked the red and blue battle plans to assure that these were valid and that the both sides were treated the same way. Similarly, Mr. Curt Pangracs of the Simulations Division set up the scenario databases and conducted the simulation runs to ensure that the author's biases were minimized.

Adequate engagement in data collection: making sure enough time is spent to collect data for the study, including attempting to find data that contradicts the study.<sup>44</sup> It is hard to define exactly how much time “enough time” is, however, work on collecting data from doctrinal documents has been ongoing for 6 months. Given that the three documents consist of approximately 600 pages in total, it is reasonable to believe that this was enough time. In the quantitative part, this factor is irrelevant as long as the results are interpreted the correct way, which is assured through the assistance of a professional statistician.

Researcher's position or reflexivity: The researcher has to apply critical reflection to all assumptions, biases and relationship to the study in order to keep it free from unscientific influence.<sup>45</sup> Completely succeeding in this task is an impossible mission. However, it is important to minimize the negative influence subjective characteristics could have in a research process. In this case, the researcher has reversed the perspective

---

<sup>44</sup>Ibid., table 9.1 3.point

<sup>45</sup>Ibid.

he had from his armored infantry background. This study argues against the truths that have been taught to the author during his career. This does not guarantee that the author is completely objective, however, together with *members check* and *peer review*, it should keep this study inside the ethical borders.

*Peer review/ examination:* there should be an ongoing discussion with colleagues about the findings and interpretations in the study.<sup>46</sup> This is done within the framework of the art of war scholarship program where members gives feedback during the whole research process. It is also helped by close communication and feedback from the thesis committee.

*Audit trail:* a clear and well-described methodology means it should be possible for another researcher to repeat the research.<sup>47</sup> Outside what is done in this chapter in explaining the methodology, the software used in the quantitative part is also used in Sweden by its LWC, and the maps, scenario and data files are included as appendix in the form of a DVD. This makes it possible to repeat the simulations and replicate the research.

*Rich, thick description:* write and report in a way that enables a reader to understand the context and its relationship to the results of the study.<sup>48</sup> This is carried out in chapters 4 and 5. Furthermore, all the simulation data is included as appendix.

*Maximum variation:* seeking variation and diversity in the sample selection in order to increase the possibility of using results from the study in a generic way.<sup>49</sup> This

---

<sup>46</sup>Merriam, table 9.1.

<sup>47</sup>Ibid.

<sup>48</sup>Ibid

was a significant factor in simulation selection, as a more complex simulation was chosen in order to ensure sufficient variation between simulation runs.

The work reasonably fulfills the ethical standards according to Merriam.

### Chapter Summary

Two different methods of research were used to answer the question about efficient utilization of Swedish forces. Initially, a qualitative case study with heuristic elements was conducted in order to get an initial result, and then a quantitative study was conducted in a computer-simulated environment to confirm or refute the result from the heuristic analysis. In both parts of the research, the same case study, Case 9, was used, which also fulfilled the role of strategic framework.

Although the simulation software has its limitations, it includes the correct forces, the actual terrain, and introduced sufficient variability, while minimizing human intervention. The simulation is also used by the Swedish Army and is unclassified. All these factors weighed together made it the most feasible choice.

To ensure validity, reliability and research ethics, Merriam's eight strategies were applied in this study, and an acceptable level has been reached.<sup>50</sup>

---

<sup>49</sup>Ibid.

<sup>50</sup>Ibid.

## CHAPTER 4

### DOCTRINAL ANALYSIS

Maybe the solution to this problem is to keep these principles as our servants. If we commit to them we will be their prisoners.<sup>51</sup>  
— The Foundations of Military Theory

#### Chapter Overview

The first step in this part of the study is to prove that Swedish Army tactical doctrine emphasizes offensive tactics over defensive tactics. The second step is to explain how the Army is supposed to attack according to its doctrine. The third step will be to analyze this offensive way of fighting in the context of Case 9, and show the problems with such tactics. The fourth step is to examine the option of using defensive tactics instead of offensive tactics in the context of Case 9. The fifth and final step is to examine the possibility of using defensive tactics to gain strategic victory.

The analysis shows that Swedish Army tactical doctrine is biased towards the offensive and states that attack is the only way to achieve victory on the battlefield. This offensive doctrine has problems, on a theoretical level due to cherry picking from its theoretical foundation, and on a practical level current state due to the army's current small size. Furthermore, within the framework of Case 9 the doctrine is hard to execute and utilizes scarce Swedish resources in a sub-optimal way. In principle, defensive tactics are more likely to result in tactical success, and can yield strategic victory as well. It is difficult to define an exact border between the tactical and the operational levels in the theoretical examples that used in this chapter, and because this study only examines army

---

<sup>51</sup>Widen and Ångström, 144.

units, it is possible to argue that there cannot be an operational level with only two brigades involved. However, the doctrinal documents are written for different audience and a separation is therefore necessary. In the following analysis, the tactical level means single engagements. The operational level means multiple engagements conducted in a coherent manner, leading to a strategic goal. Also note that Swedish Army doctrine is not offensive at the strategic level, where its primary task is to defend Sweden in Sweden

### The Offensive Bias in Current Swedish Doctrine

There is no clearly stipulated ratio between offensive tactics and defensive tactics in the doctrine, which discusses both ways of fighting with a similar focus. It is even possible to argue that it is more focused on a defensive way of fighting than on an offensive way because there are more chapters dedicated to defensive operations than the offensive one.<sup>52</sup> Furthermore, when land operations are described, the doctrine stresses that they could be offensive, defensive, stabilizing, or supporting.<sup>53</sup> A quick glance at the different doctrinal documents could therefore give the reader perception that doctrine favors a defensive way of fighting or at least takes a balanced view of the two.

However, this is not the case. The imbalance between offensive and defensive is evident in three different areas and a close analysis of those clearly shows that Swedish doctrine prescribes offensive warfighting on both the tactical and operational level. The

---

<sup>52</sup>Försvarsmakten, *Arme reglemente Taktik 2013*. Chp.7 “way of conducting combat” one chapter is dedicated to attack/assault [Anfall], one to static defense [Försvar] one to “delaying actions”, [Fördröjning] and the last one to mobile defense [Avvärjningsstrid].

<sup>53</sup>Försvarsmakten, *Arme reglemente Taktik 2013*,43.

three different areas are: the way the doctrine defines maneuver warfare; how it perceives the way to military victory; and how it describes the purpose of defensive operations.

Before moving on it is important to note that one of the on Swedish Army doctrine, LTC Stefan Eriksson, Director of the Training Department, LWC, does not agree with the following analysis. His opinion is that the doctrine as a whole is balanced and that the examples in the doctrine must be put in a wider context, where the Swedish Navy and Air Force are shaping the opponent in a way that makes the concepts of maneuver warfare and local superiority valid.<sup>54</sup> However he acknowledges that a decisive result is necessary to achieve Sweden's strategic goals, and that a decisive result can only be achieved through offensive operations.<sup>55</sup> LTC Ola Palmqvist stresses that the doctrine shall be seen as a conceptual guidance of how Sweden should defeat a superior opponent. Exact numbers of available units are not of decisive importance in the doctrinal context.<sup>56</sup>

#### The Offensive Bias in the Swedish Interpretation of Maneuver Warfare

According to Swedish doctrine, maneuver battalions should always utilize maneuver warfare when conducting any form of tactical activity.<sup>57</sup> Maneuver warfare is explained as a further development of the "Indirect Approach", a way of fighting against

---

<sup>54</sup>Shaping should be understood as operations that affect the Army's capability to solve its tasks. Could for example be to sink a part of the ships that carries the opponents attack force.

<sup>55</sup>LTC. Eriksson, Mail correspondence with author.

<sup>56</sup>LTC. Palmqvist, Mail correspondence with author.

<sup>57</sup>Försvarsmakten, *MSR 6 FU*, 36.



an opponent that is equal or stronger than yourself.<sup>58</sup> The essence of the indirect method is explained as: “Against a superior opponent we have to engage in deep attack and strike against his lines of communications, C2 capabilities, and other critical vulnerabilities.”<sup>59</sup>

Maneuver warfare is further described as a way of fighting where units “by fire and quick movements expose the opponent to multiple and accelerating threats.”<sup>60</sup> This can result in a systemic collapse for the opponent.<sup>61</sup>

Maneuver warfare is also described as a way of fighting in order to reach decisive results against a superior opponent and is conducted by:

1. Finding the enemy’s weaknesses and strengths
2. Influencing the opponent
3. Using fires in order to enable maneuvers
4. Defining a common end state and the use of mission command
5. Using initiative and a high tempo<sup>62</sup>

The goal is to attack the opponent’s weaknesses and avoid his strengths.

Weaknesses are exemplified as: “[The enemy’s] flanks, gaps in deployment, or units with low combat power. These weaknesses could be used in order to achieve penetration

---

<sup>58</sup>Försvarsmakten, *Arme reglemente Taktik 2013*, 23.

<sup>59</sup>*Ibid.*, explanation of the concept of “Indirect Approach.”

<sup>60</sup>*Ibid.*, 35.

<sup>61</sup>*Ibid.*

<sup>62</sup>*Ibid.*, 37.

where the opponent is weakest; this should be exploited by continued attack in depth to degrade his C2 capability.”<sup>63</sup>

Weaknesses are discovered by offensive tactics, because it would be hard to achieve penetration or conduct a continued attack in depth with defensive tactics.

In order to influence an opponent in an efficient way, his will to fight must be degraded.<sup>64</sup> According to doctrine, this should primarily be done by fires. To maximize the effect of those fires, the opponent’s strengths must be dislocated. Dislocation in space is exemplified as an envelopment or a flank attack.<sup>65</sup> Both envelopment and flank attack demand an offensive method of warfighting.

The next concept in conducting maneuver warfare is also built on offensive tactics. While the use of fires in order to enable movement could be used both in the defense and the offense, the doctrine states that this combination projects threat’s and effects into the depth of an opponent’s deployment.<sup>66</sup> It is the depth of the opponents deployment that is to be effected and not ones own forces depth, this clearly indicates that the movement that the fire enables should be offensive.

In the two last areas; the creation of a common end state combined with the use of mission command, and initiative combined with high tempo, cannot be exclusively

---

<sup>63</sup>Försvarsmakten, *Arme reglemente Taktik 2013*, 38.

<sup>64</sup>Ibid.

<sup>65</sup>Ibid., 39.

<sup>66</sup>Ibid.

associated with offensive or defensive warfighting.<sup>67</sup> However, in both *Tactical Regulations for the Army* and *Regulations for Maneuver Battalion* the same picture is shown in order to visualize maneuver warfare, which clearly indicates an offensive way of fighting:

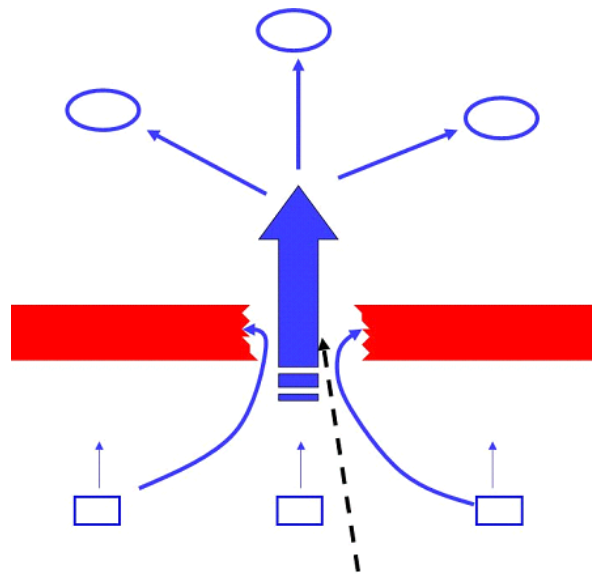

Figure 2. Description of maneuver warfare

Source: Försvarsmakten, *Arme Reglemente Taktik 2013* [SAF, Tactical Army Regulation 2013] (Stockholm: Försvarsmakten, 2013), 41.

Swedish Army doctrine states that a maneuver battalion should always use maneuver warfare tactics.<sup>68</sup> Maneuver warfare is built upon the indirect approach, which in turn is explained as an attack in depth. Furthermore, when the doctrine explains how

---

<sup>67</sup>Initiative and high tempo could be used in the initial stage of a defensive operation in order to deploy and prepare for defense in a timely manner. Later on, it is useful in a mobile defense.

<sup>68</sup>Försvarsmakten, *MSR 6 FU*, 26.

maneuver warfare is to be conducted, three out of five concepts are clearly offensive while the remainder are both offensive and defensive. The fact that all examples of maneuver warfare in the doctrine are based on offensive operations and attacks further increases the bias towards the offensive. Thus, the analysis of the definition of maneuver warfare proves that the Swedish doctrine interprets the concept of maneuver warfare as an offensive way of conducting warfighting.

### The Offensive Bias in the Concept of Decisive Results

The concept of decisive results is used in a slightly different way in Swedish doctrine than in the US Army doctrine.<sup>69</sup> Swedish doctrine defines a decisive result as one that is crucial, definitive and conclusive; a result that will significantly impact the battle, the engagement or the operation. In a purely linguistic sense, a decisive result could be either positive or negative. However, in the context of the doctrine a decisive result [avgörande] should be interpreted as something positive, quite close to a decisive victory. As stated in the doctrine when defining the concept of tactics: “The ability of enlisted soldiers, as well as commanders on all levels, to take initiative and reach decisive results on the battlefield, is the factor that enables us to reach our operational, as well as our strategic goal.”<sup>70</sup>

If a decisive result were the way to reach our operational and strategic goals on the battlefield, it seems fair to say that the phrase “decisive results” should be interpreted

---

<sup>69</sup>It is used in many different meanings such as “decisive actions” which has replaced “Full Spectrum Operations”. It is also used in “decisive points”, “Decisive operations”, and so on.

<sup>70</sup>Försvarsmakten, *Arme reglemente Taktik 2013*, 20.

as decisive victory rather than decisive defeat. The decisive result is linked to the doctrinal explanation of the different kinds of land operations. It states that a land operation with an offensive approach is characterized by: “the fact that we [Swedish Army] seize and retain the initiative or reach a decisive result on our conditions. Exclusively by the means of an attack can a decisive result be achieved.”<sup>71</sup>

Given this analysis, Swedish doctrine’s way of achieving Sweden’s strategic and operational goals on the battlefield is to achieve a decisive result. The only way to achieve such a result is, according to doctrine, by means of attack and offensive land operations. This clearly indicates that offensive tactics are the doctrinally correct way of conducting warfighting, at least if you as a commander want to achieve the assigned operational and strategic goals.

#### The Offensive Bias in Defensive Land Operations

As stated in the first paragraph in this chapter, a quick review of Swedish doctrine could give the overall impression that its operational and tactical doctrine is defensive in nature rather than offensive. So what is the purpose of all the chapters about defensive tactics, if the doctrine is purely offensive? The definition and purpose of defensive land operations, found in doctrine, provides a clear answer:

A land operation with a defensive approach is conducted in order to get a more favorable position, or to stop a deteriorating situation. In a defensive land operation the purpose is to gain time in order to enable an offensive land operation in the future. The primary methods of combat when using a defensive approach are delaying actions, static defenses and mobile defenses.<sup>72</sup>

---

<sup>71</sup>Försvarsmakten, *Arme reglemente Taktik 2013*, 46.

<sup>72</sup>Ibid.

The statement above is clear: The Swedish Army should only conduct defensive operations for a limited period in order to enable a shift to the offensive as soon as possible.

The one-sided view in the doctrine is interesting, especially given that US Army doctrine states that it is possible to size and retain the initiative through defensive operations.<sup>73</sup> The amount of resources available to the US and Swedish armies respectively, would make it seem more logical the other way around.

This initial part of chapter 4 has shown that the Swedish Army's tactical and operational doctrine is offensive and that a defensive method of fighting only should be used during a short time in order to, as soon as possible shift back to an offensive method. The following part will explain how this offensive method should be conducted in order to succeed.

#### Conducting the Doctrinal Swedish Offensive

According to the fundamentals in military theory, presented in Chapter 3 defensive tactics are stronger than offensive tactics.<sup>74</sup> Sweden's potential opponents have more military resources than Sweden, which means that according to this, a defensive tactical and operational doctrine would be a logical choice, especially if the resource difference is significant. However, Sweden's doctrine emphasize the offensive even though the latest Swedish defense reforms have reduced the army to two maneuver brigades.

---

<sup>73</sup>Headquarters Department of the Army, Army Doctrine Reference Publication 3-90 (Washington, DC: Government Printing Office, August 2012), 4-8, 4-10.

<sup>74</sup>Clausewitz, 360.

In order to justify this apparent discrepancy from military theory the tactical and operational doctrine relies on two main concepts: maneuver warfare, and local superiority. In the following paragraphs, these concepts will be explained in order to facilitate the analysis.

#### Conducting the Doctrinal Swedish Offensive: Maneuver Warfare

Maneuver warfare stems from maneuver thinking, which in turn has its roots in the principle of the indirect approach. Using the indirect approach means to attack the opponent's critical vulnerabilities or weaknesses instead of its strengths. If the indirect approach is successful, the opponent's vital capabilities are neutralized, or affected in a way that they are made irrelevant. This will in turn lead to a systemic collapse,<sup>75</sup> which renders the opponent defenseless and ultimately defeated.<sup>76</sup>

The armed execution of the maneuver-thinking concept is maneuver warfare. It is a concept that enables a smaller force to defeat a superior one. It is an efficient way of using forces because it focus on the weaknesses of the enemy instead of the strengths.<sup>77</sup>

A vital part in this concept is the center of gravity (COG) analysis, a staff process that aims to identify one's own and the opponent's critical vulnerabilities, or weaknesses.<sup>78</sup> The COG is described as the vital factor that gives one side in a conflict

---

<sup>75</sup>A concept used to describe a total loss of ability to continue to fight which leads to defeat.

<sup>76</sup>Försvarsmakten, *Arme reglemente Taktik 2013*, 75.

<sup>77</sup>*Ibid.*, 35.

<sup>78</sup>*Ibid.*, 36.

the power and capability to achieve its goals. Each level of conflict: strategic, operational, and tactical has its own COG. In Swedish doctrine, it is exemplified as the will of the people on the strategic level and as military units or objects at the operational and tactical levels. A center of gravity is built upon one or more vital capabilities, which are crucial in order to reach the end state. These vital capabilities have critical requirements that are necessary in order for the vital capabilities to function. When these critical requirements have significant limitations that can be affected by an opponent, They become critical vulnerabilities. The opponent's critical vulnerabilities are the targets in maneuver warfare, and should be attacked while protecting your own critical vulnerabilities.<sup>79</sup>

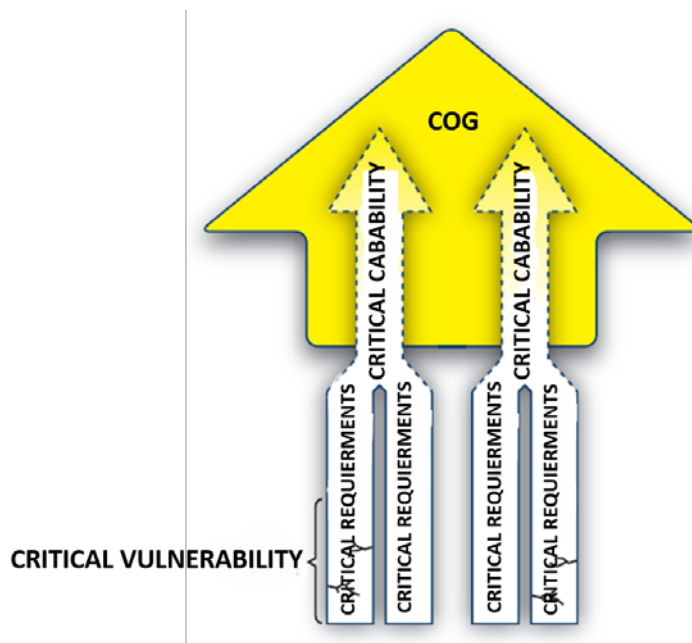

Figure 3. Relationship between Center of Gravity and Critical Vulnerability

Source: Försvarsmakten, *Arme Reglemente Taktik 2013* [SAF, Tactical Army Regulation 2013] (Stockholm: Försvarsmakten, 2013), 37.

<sup>79</sup>Försvarsmakten, *Arme reglemente Taktik 2013*, 36.



In order to conduct successful maneuver warfare, the first step is to conduct a correct COG analysis. This is crucial in order to identify and neutralize the opponent's critical vulnerabilities in time. However, the opponent's system might be more resilient than expected; if so, there will be no collapse of the opponent's system.<sup>80</sup>

The first and crucial step in the Swedish execution of maneuver warfare is to conduct a COG analysis using the described methods. The method will later be applied in the context of Case 9.

Maneuver warfare on the unit level has already been briefly described in the first part of this chapter. However, that explanation did not examine the tactical guidelines to support a commander in conducting the fight once the opponent's critical vulnerability is identified. In *The Regulations for Maneuver Battalions*, there is more information about how to conduct maneuver warfare. It states that the most important tool in engaging the opponent is the use of combined arms. Combined arms gives the possibility of compensating for friendly weaknesses, but also of putting the opponent in an unfavorable situation. The doctrine exemplifies the use of combined arms as: "We (Swedish maneuver units) are using anti-tank weapons and mines to engage the opponent's main battle tanks while our own main battle tanks conduct attack in depth and engage the enemy's sustainment units."<sup>81</sup> According to the concept of maneuver warfare, the critical vulnerability in this example would be the opponent's sustainment units.

---

<sup>80</sup>Försvarsmakten, *Arme reglemente Taktik 2013*, 37.

<sup>81</sup>Försvarsmakten, *R FM MSR 6 Manöverbat FU*, 52.

Another form of applying the concept of maneuver warfare is dislocation,<sup>82</sup> which can be conducted in three different ways: dislocation in space, dislocation in time or functional dislocation. The concept of dislocation came from Basil Liddell-Hart's idea the indirect method, and Edward L. Luttwak's concept of "Systemic Disruption".<sup>83</sup> Dislocation in space deflects the opponent's strengths in a direction that makes it weak or irrelevant. This could be achieved by conducting fast movement and maneuver with our own units.<sup>84</sup>

A dislocation in time is achieved by neutralizing an opponent's superiority by using temporal measures. It can be achieved by acting faster or slower than an opponent expects us to do. It can also be done by delaying the opponent or making it harder for him to observe our actions. An example given in the doctrine is neutralizing the opponent's superiority in the area of indirect fires by maneuvering at such a high rate of speed and from such an unexpected direction that there is no time for the opponent's systems to be used against our units.<sup>85</sup>

---

<sup>82</sup>The Swedish word used is {Förskjutning} which also could be translated to "Displacement or Shifting". However, the word dislocation is the most accurate translation in this context and is similar to the US expression of asymmetric warfare.

<sup>83</sup>Widen and Ångström, 184.

<sup>84</sup>Försvarsmakten, *R FM MSR 6 Manöverbat FU*, 52.

<sup>85</sup>Ibid.

Functional displacement aims at neutralizing the opponent's technical superiority with "*certain techniques*"<sup>86</sup> or the use of combined arms. The doctrinal example is rifle company's use of AT fire and AT mines to destroy the opponent's main battle tanks.<sup>87</sup>

Swedish doctrine also stresses the importance of using fires as a mean to enable movement and maneuver. It states that by combining fires and maneuver in a high tempo, it is possible to close in on the opponent, putting the enemy in a situation where it cannot conduct effective countermeasures. This in turn leads to his will to fight disappearing.<sup>88</sup>

Furthermore, Swedish tactical and operational doctrine emphasizes the importance of mission command and a clear and shared end state. The commander should give the end state, purpose, tasks and tactical framework to his subordinates. He should also allocate sufficient resources and give the subordinates the maximum amount of freedom when it comes to how the end state should be achieved.<sup>89</sup> The main purpose of mission command is to mitigate friction and enable initiative on all levels. This leads to an increased capability to exploit fleeting opportunities and thus to fight at a higher tempo than the opponent, which increases the possibility of neutralizing his critical vulnerabilities.<sup>90</sup>

---

<sup>86</sup>[viss teknik] It is not not specified what these could be, but different kinds of technical countermeasures is likely to be in this category. Försvarsmakten, *R FM MSR 6 Manöverbat FU*, 52.

<sup>87</sup>Ibid.

<sup>88</sup>Ibid.

<sup>89</sup>Ibid., 53.

<sup>90</sup>Försvarsmakten, *R FM MSR 6 Manöverbat FU*, 53-54.

In short, Swedish doctrine states that maneuver warfare is conducted by conducting a center of gravity analysis, which leads to identified critical vulnerabilities. These vulnerabilities are attacked or otherwise affected by the use of combined arms and fires which enable movement. This action is lead by mission command, which makes it possible to take the initiative and fight at a higher tempo than the opponent does.

Even though the essence of maneuver warfare is to affect the opponent's critical vulnerabilities, Swedish doctrine states that sometimes such an approach is not possible. In these cases, an attack against the opponent's strengths, a direct approach is necessary. In order to succeed in direct approach, local superiority has to be created and used.<sup>91</sup>

#### Conducting the Doctrinal Swedish Offensive: Local Superiority

Local superiority is a key concept in Swedish Army doctrine, designated to implement the offensive method. It is described as the foundation for all tactics and is achieved by combining the principles of warfare that are perceived as most important by the authors of both the operational and tactical doctrine.<sup>92</sup> Local superiority increases the possibility of reaching a decisive result in a chosen time and space and being stronger than the opponent. This is done by massing the effects of different weapon systems to a defined space at a defined time and in terrain where the opponent has difficulty in getting the full effect of his superior firepower or mobility. Due to the dynamics of land warfare, it is important to have reserve units at the time and in the area where this massing of

---

<sup>91</sup>Försvarsmakten, *Arme reglemente Taktik 2013*, 38.

<sup>92</sup>Försvarsmakten, *R FM MSR 6 Manöverbat FU*, 42,44.

effects is conducted. Furthermore, it is often necessary to divide and block part of the opponent's forces in order to achieve local superiority.<sup>93</sup>

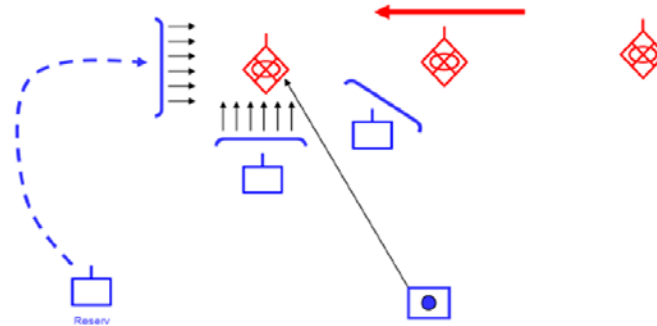

Figure 4. How local superiority is achieved

*Source:* Försvarsmakten, *R FM MSR 6 Manöverbat FU*,

Note that this picture shows a defending blue side, which provides an interesting disconnection between the doctrine and its example. Doctrine directs the use of local superiority for the offense. The diagram shows an overall 1:1 force ratio, but the blue force is using defensive tactics.

The principles of warfare that are the most important for the Swedish Army and that must be combined in order to achieve this favorable situation are: Clear and understandable goals, mass of force, surprise, and freedom of action.<sup>94</sup>

Clear and understandable goals are necessary to enable subordinates to adapt to a changing operational environment and exploit opportunities. It is more important to

---

<sup>93</sup>Försvarsmakten, *R FM MSR 6 Manöverbat FU*, 43.

<sup>94</sup>Försvarsmakten, *R FM MSR 6 Manöverbat FU*, 44, 45. Goals could also be translated to the aim of the operation, or end state. Freedom of action means the ability to act in an un-planned way, and should not be interpreted, as used in the US Doctrine, as a part of Mission Command.

conduct actions that lead towards the goal than to follow the plan. To achieve this, the battalion commander creates a clear and easily understandable graphic of the end state that is communicated to subordinate units.<sup>95</sup>

Concentration of force is conducted by massing effects in a limited and defined space and time. There can only be one concentration of force at the same time and space and all efforts in the unit must support this main effort. In order to achieve an efficient concentration of force, risks have to be taken in other areas. This could mean that a flank is left undefended or that an opponent is bypassed.<sup>96</sup>

Surprise is vital in order to achieve local superiority. It is conducted by means of deception, concealment, and unconventional behavior.<sup>97</sup> Deception tricks the opponent or enhances deficiencies that already exist within the opponent's organization. Concealment is achieved by using terrain, camouflage, signal discipline, and operations security. Unconventional behavior could be achieved through maneuvering at a higher tempo or in a terrain that the opponent could not foresee.<sup>98</sup>

Finally, freedom of action is needed in order to achieve local superiority. This principle is vital in order to ensure the ability of exploit fleeting opportunities and act against emerging threats. It is enabled by flexibility in planning and conducting activities

---

<sup>95</sup>Försvarsmakten, *R FM MSR 6 Manöverbat FU*, 45.

<sup>96</sup>Försvarsmakten, *R FM MSR 6 Manöverbat FU*, 46. Concentration of force could be compared to the U.S. Army doctrine concept of "main effort." However, the Swedish concept is more absolute and implies bigger risks. It is more similar to the German concept of "schwerpunkt".

<sup>97</sup>Unconventional behavior {oväntat uppträdande} is used to define the concept of acting maneuvering in a way that is hard for the opponent to foresee.

<sup>98</sup>Försvarsmakten, *R FM MSR 6 Manöverbat FU*, 47.

within a clear commander's intent. At the battalion level, freedom of action is created by making necessary decisions in a timely manner, maintaining reserves, and acting preemptively.<sup>99</sup>

Maneuver warfare and local superiority are the methods the Swedish Army intends to use to fight and win against an opponent that has a significant superiority in numbers. Although the Swedish Army could have a certain qualitative superiority when comparing certain platforms, the opponent is assumed to have a greater variety of military tools.<sup>100</sup> Are these concepts of maneuver warfare and local superiority powerful enough to enable successful offensive tactics despite an inferiority in numbers? The following analysis shows that this is not the case.

#### Testing Doctrine Using Case 9: Case 9 in Detail

After the initial air assault and naval landing, Case 9 expects four opposing mechanized brigades to attack from secured SPODs east of the Swedish capital. The aim of the attack is to seize key areas within the capital as soon as possible. The avenues of approach is limited between the SPODs and the capital because there are few roads running through the hilly and densely forested terrain. There are two main roads in the area that could be used for the attack. In the scenario, the opponent chooses to initially attack with one brigade along each of the two roads and keep two brigades in reserve, one in each of the two SPODs. Logically, if blue's first brigade is attacking the SPODs, the

---

<sup>99</sup>Försvarsmakten, *R FM MSR 6 Manöverbat FU*, 48.

<sup>100</sup>The Swedish MBT has better capabilities than its opponent, likewise for the IFV. However, the opponent has tactical ballistic missiles and rocket artillery, which Sweden does not possess.

second brigade and the Home Guard must hold the rest of the front line and react to Red's air assault units near Stockholm. The Home Guard units have little or no operational maneuverability, and local units cannot be expected to contain a mechanized air assault battalion for very long. Therefore, the second Blue brigade is the only force available to contain, let alone defeat, these air assault forces. In addition, the second brigade must contain the beachhead around the SPODs, and, if Swedish doctrine is followed to the letter, it must attack alongside the first brigade. If the first brigade takes on some of these missions, then its attack will be weakened.

The Swedish strategic goal is to remain a sovereign state and its operational goal within this scenario is to prevent the opponent from achieving its operational goal. Case 9 assumes that due to the international system and Sweden's membership in the European Union, time is of utmost importance. If Sweden can deny the opponent access to its operational goal (the Swedish capital) for more than 10 days, the EU is expected to intervene. Therefore international pressure against the opponent will make it weaker and at the same time, international military and political support will make Sweden stronger.<sup>101</sup>

#### Testing Doctrine Using Case 9: Applying Maneuver Warfare

The first step in a successful maneuver fighting is, as earlier reported, to identify the opponent's weaknesses; in order to decide what object or capability within the opponent that should be attacked or otherwise affected.<sup>102</sup>

---

<sup>101</sup>Case 9, ANNEX C.

<sup>102</sup>Försvarsmakten, *Arme reglemente Taktik 2013*, 37.



What is the enemy's operational critical vulnerability in this case? A somewhat simplified center of gravity analysis is: The enemy's mechanized brigades are the source of its ability to achieve its operational goal (the seizure of key parts of the Swedish capital of Stockholm). These Brigades are the most efficient tool to reach the goal and without them, he will fail. This tells us that his maneuver brigades in Sweden are the opponent's operational center of gravity.

Mechanized units achieve their goals by performing maneuver and fires, which makes these the brigades' critical capabilities. In order to fire and maneuver, the brigades need ammunition, fuel, and other types of logistical support, which makes their logistical support a critical requirement. Within these critical requirements, one or more logistical item could be a critical vulnerability. With the information Case 9 provides, it is not possible to decide if there are some logistical items that are scarce, or if there are some other critical requirements that are vulnerabilities. With the available information, the opponent's sustainment units are the critical vulnerabilities.

Thus, within the framework of maneuver warfare, the sustainment units that supply the mechanized brigades would be a perfect target for an attack. They are weak and relatively easy to destroy compared to the tanks and armored vehicles in the mechanized brigades, and if they are destroyed, the brigades will lose their fighting power.

It would be equally good, in a maneuver warfare sense, to attack and re-take the SPODs that are currently under the control of the opponent. These are as vital as the sustainment units for supporting the maneuver brigades with necessary supplies. The

SPODs are also vital for reinforcement and a vital link to the opponent's logistical home base.

Both the sustainment units and the SPODs are valid targets for an attack according to the Swedish doctrine and its maneuver warfare concept. Indeed a attack against sustainment units is the example used in describing maneuver warfare in Swedish doctrine.<sup>103</sup>

At least two challenges arise in executing such an attack. One is the Swedish army force structure and its limited amount of maneuver units, and the other one is the character of the Swedish terrain.

The Swedish Army's limited numbers of maneuver units by itself presents numerous challenges, if Swedish doctrine is to be followed. The first is how to avoid a frontal attack against the enemy's hard frontal units and still reach the identified critical vulnerabilities, while at the same time protecting Sweden's center of gravity. In order to avoid engagement with the opponent's main combat elements, some kind of envelopment or bypassing of these units must be conducted. However, there are not sufficient Swedish forces to defend while doing this and thus the opponent will have free passage to its operational goal and Sweden's center of gravity. Both tasks have to be conducted at the same time which is impossible: with only two brigades. Sweden can either attack head on and take a risk by not defending its COG, or defend first and, maybe, attack later.

---

<sup>103</sup>Försvarsmakten, *Arme reglemente Taktik 2013*, 37. "Opponents units with low combat effect."

Defending two roads against two brigades requires at least one brigade.<sup>104</sup> That leaves one brigade for the attack if no operational reserve is deemed necessary.<sup>105</sup> In the scenario, the SPODs are not a feasible target for an attack given that there are brigade size units in the vicinity of these which makes them targets as difficult as the advancing brigades. This leaves us with the sustainment units as the most feasible target. With a closer look at the terrain, these targets are probably also very difficult to destroy. The distance between the capital and the SPODs is 70 miles (110 km) and 35 mi (56 km) respectively. A mechanized brigade uses 30-60 miles (50-100 km) of road when marching, which suggests that there will not be any isolated sustainment units along the avenue of approach. Furthermore, the small distance between the SPODs and the capital makes it easy for the opponent to reinforce units under attack, or to conduct a counterattack against the attacking Swedish brigade.

There are not likely to be any unprotected targets suitable for an attack with a brigade size unit in Case 9. Furthermore, even if Swedish intelligence were to find some other critical vulnerability, the small area of operations combined with Sweden's inferior numbers makes it possible for the opponent to reinforce or counterattack within such a short time frame that the risks of an attack are impossible to eliminate.

Compounding this first challenge is the terrain in itself. It is, as mentioned earlier, highly canalizing; conducting movement or maneuver outside the roads is almost

---

<sup>104</sup>Given the number of tanks and the fires capabilities within the opponent brigades, this gives a force ratio of approximately 1:2.5 which should be sufficient if the defending units gets at least 6 hours of preparation time.

<sup>105</sup>Probably this will never happen, but for the sake of the analysis, the attack will be conducted despite this fact.

impossible. Given that the opponent is attacking along the existing roads it will be almost impossible to reach the sustainment units or the SPODs for an attack without first engaging his maneuver units. There are limited numbers of places where an attack could envelop or, indeed, where it is possible to maneuver with units above company size.

The canalizing terrain also makes it difficult to conduct the battle according to the doctrinal concept of temporal and spatial dislocation during an attacking movement. The terrain will force the blue and red units to fight an attrition type combat on the tactical level because neither side will be able to by-pass the other's armored units.

These challenges suggests that within the framework of Case 9, offensive maneuver warfare tactic are not the most efficient way of using Swedish forces due to critical vulnerabilities, the terrain, the inferior numbers, and the risk involved in attacking when the attacking force is limited to two brigades.

Furthermore, there is a further aspect of risk in maneuver warfare theory that Swedish doctrine ignores. Swedish maneuver warfare doctrine is largely based on Edward N. Luttwak's *Strategy: The Logic of Peace and War*<sup>106</sup> and William S. Lind's *Maneuver Warfare Handbook*<sup>107</sup>. Luttwak describes maneuver warfare as an opportunity for a weaker force to defeat a stronger force, which corresponds well with the Swedish explanation of maneuver warfare.<sup>108</sup> However, Luttwak also describes maneuver warfare

---

<sup>106</sup>Edward N. Luttwak, *Strategy: The Logic of War and Peace* (Cambridge, MA: Belknap Press, 2001).

<sup>107</sup>William S Lind, *Maneuver Warfare Handbook* (Boulder, CO: Westview Press, 1985).

<sup>108</sup>Luttwak, 115.

as a way of war that can “fail catastrophically”.<sup>109</sup> Thus, one of the primary sources of Swedish doctrine tells us that while maneuver warfare can give greater results in a shorter amount of time and with smaller forces than attritional warfare, maneuver warfare is also significantly more risky than attritional warfare.<sup>110</sup>

Luttwak claims that to avoid disaster, the maneuvering forces’ analysis must be correct, the forces must be powerful enough to accomplish their missions, and the maneuvering units must be qualitatively superior to their opponent, especially in speed and precision.<sup>111</sup>

This deeper explanation of maneuver warfare explains two possible issues with Swedish doctrine and the concept of maneuver warfare. The first issue is that, because both of the brigades would have to be engaged in order to conduct maneuver warfare in Case 9, and those two brigades are the ultimate guarantor for Swedish sovereignty, it would be a gamble to commit these in a manner that, if they fail, would lead to immediate defeat.<sup>112</sup> The second issue is that, given the last twenty years of reductions, it is not certain that the Swedish army has a significant qualitative superiority in the areas of speed and precision against an opponent.

---

<sup>109</sup>Luttwak, 115.

<sup>110</sup>Attritional warfare occurs when the two sides of a conflict attack each other’s strengths, and the amount of firepower and number of military units are the factors that decides which side is going to win. (Luttwak, chp 7)

<sup>111</sup>Luttwak, 115.

<sup>112</sup>According to the examples in the doctrine, both Swedish brigades are used to destroy one opponent brigade. Given the fact that the opponent attacks with four to six brigades in this scenario there is a significant risk that at least two brigades would be engaged in an attack against each Swedish brigade.

When comparing the doctrine with Luttwak's work it seems that the authors of the doctrine has chosen to use some parts of Luttwak's theory of maneuver warfare, such as the overall definition and the possibilities, while excluding some parts, such as the risks for catastrophic failure and the explicit need to be qualitatively superior. Admittedly, there is no proof that Luttwak's maneuver theory is fully correct, and a nation's doctrine does not have to follow one theory. However, Swedish doctrine is explicitly based on Luttwak's theory, and it is dangerous to use only the positive parts of a theory while disregarding the risk prerequisites.<sup>113</sup> This could lead to a doctrine that is unrealistically positive towards maneuver warfare while other methods are discarded for the wrong reasons.

When an indirect approach cannot be used, Swedish doctrine says that the concept of local superiority should be applied against the opponent's strengths. The same method used in the analysis of maneuver warfare is applied to the concept of local superiority.

#### Testing Doctrine Using Case 9: Applying Local Superiority

The Swedish concept of local superiority is not a concept that exists in military theory, but, as explained earlier, local superiority is a combination of four common principles of war. These are: clear and understandable goals, concentration of force, surprise, and freedom of action. The interpretation of these principles is the same in Swedish doctrine as in military theory. However, these principles of warfare are described as common knowledge or generic truths, which could be dangerous. Some of

---

<sup>113</sup>It is worth noting that Luttwak also states that maneuver warfare is mainly to be conducted on the operational level of war, while on the technical and tactical levels the fighting will be predominantly conducted in an attritional manner; while Swedish doctrine applies maneuver warfare down to the tactical level. (Luttwak chp.7)

the principles are new, from a historical perspective, and others have been completely changed or somewhat modified during the last 50 years.<sup>114</sup> This indicates that the principles are not timeless and should be treated with certain amount of skepticism. An example of a principle that has changed is the principle of the superiority of offensive warfighting. The perception that offensive warfighting provided a safe way to victory was prevalent before the First World War, but this perception reversed for some of the participating countries during and after the war.<sup>115</sup>

When dealing with the principles, it is also important to remember that the opponent should not be using the same once If both side use the same doctrine, they risk neutralizing each other.<sup>116</sup> An example of this is the Napoleon wars where Napoleon's opponents copied his way of conducting war (or the principles of Jomini) in order to neutralize his advantage.<sup>117</sup>

This is interesting given the fact that Sweden's possible opponents are using two, three or four out of the four principles that the concept of local superiority is built upon.<sup>118</sup> This means that even if the principles are fully applied the best-anticipated effect of those is 50 percent of the full effect, if the theory of mutual neutralization is correct.

---

<sup>114</sup>John I. Alger, *The Quest for Victory: The History of the Principles of War* (Westport, CT: Greenwood Press, 1982), xix.

<sup>115</sup>An example is France and its shift to defensive strategy and tactics after First World War, including the Maginot Line and priority to firepower when designing tank.

<sup>116</sup>Widen and Ångström, 140.

<sup>117</sup>*Ibid.*, 157.

<sup>118</sup>*Ibid.*, 125. Table 1 and 2 shows that one possible opponent uses the principles concentration and surprise. The other one is using all four principles that the concept of "local superiority" is based on.

Furthermore, the concept of local superiority is relative; it is about being temporarily stronger than your opponent in a specific physical location. In order to succeed, one side must be impeded in massing forces at the same time that the other side successfully masses his. This could be difficult in the framework of Case 9 for multiple reasons some are similar to the challenges with maneuver warfare, and some are new.<sup>119</sup>

One similar difficulty is the terrain; if it is hard to maneuver outside the roads, it will be hard to mass forces as well. If the passable terrain is 50 meters wide, that fact by itself sets physical constraints on the number of units that it is possible to deploy in a meaningful way. Furthermore, because the enemy is attacking on two roads that both have the same limitations of maneuver, it is likely that he will deploy the maximum number of units in that same type of terrain. This makes relative local superiority hard or impossible to achieve.

However, local superiority can be achieved by means other than tanks or soldiers, by long-range systems such as artillery. Systems like these are in use by both the opponent and by the Swedish Army. However, given the available forces of these kinds in Case 9, it will be hard for Sweden to achieve relative local superiority by using those systems. Instead, in Case 9, the opponent has a significantly greater ability to mass these kinds of systems than the Swedish Army does.<sup>120</sup>

Due to the terrain and the goal of the opponent's attack, there are not a lot of places where either sides can mass systems except along the avenues of attack, which

---

<sup>119</sup>Widen and Ångström, 133.

<sup>120</sup>The ratio of indirect fires systems is approximately 3:1. Source: Red Organization Appendix A.



means that both sides will mass their forces in the same area. This in turn makes it hard or impossible for either side to reach local superiority. Again, the tactical engagement is likely to be an attritional, which in Case 9 is likely to lead to a Swedish defeat due to inferior numbers.

The other challenge, related to the indirect approach and local superiority is the small number of available Swedish Army units. To achieve surprise, keep freedom of action, and mass forces without risking a quick defeat when attacking with two brigades against four to five enemy brigades, is not an easy task. In Swedish doctrine, there are examples of how to conduct a battle, but in all the examples, two Swedish brigades are fighting one enemy brigade.

There is no information about other units protecting Sweden's centers of gravity or fixing additional opposing units. Apparently, the example used in Swedish doctrine is not Case 9, nor is it the scenario that caused the Swedish supreme commander to assume that the Swedish Armed Forces only could defend Sweden for one week. It seems that Swedish doctrine has another scenario in mind, or has more Swedish units at its disposal.

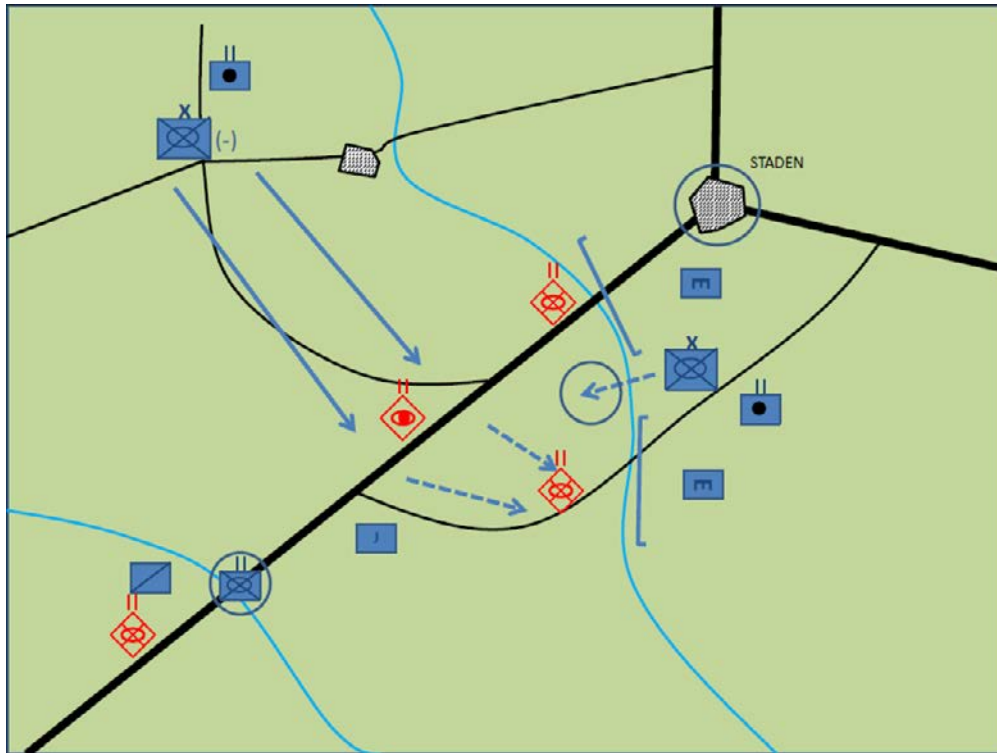

Figure 5. Example of offensive land operations

Source: Försvarsmakten, *Arme Reglemente Taktik 2013* [SAF, Tactical Army Regulation 2013] (Stockholm: Försvarsmakten, 2013).

Note: As mentioned in chapter 2, it is not wise to build a doctrine to fit the most favorable scenario, which is what this picture shows.

### Is the Offensive the Only Route to Victory?

The offensive is stated to be the *only* way to achieve decisive results and decisive victory but is this true? In addition, is the offensive the only tactical and operational way to reach Sweden's strategic goal in the framework of Case 9?<sup>121</sup>

---

<sup>121</sup>In this discussion decisive victory will be used; a decisive result is, logically, achieved for both parts at the same time on the same level, otherwise it is not decisive. If an attacker wins a decisive victory against a defender, the defender has to suffer a decisive loss. Both the attacker and the defender, however, have been exposed to a decisive *result*.

To start with the first question, there are no unchallenged answers to be found in military theory. However, the view that offensive operations and tactics are the way to achieve decisive victory is one of the key assumptions in the Western way of military thinking.<sup>122</sup> In most cases, history also supports this claim.<sup>123</sup> However, there are examples reaching from Europe during the 12th Century to present day Middle East, where a decisive result on the strategic level has been gained without offensive warfighting.<sup>124</sup> In addition, a purely theoretical discussion suggests that it is possible on all different levels of war.

For example, imagine a brigade attacking along a narrow avenue of approach. On both sides of this approach a defender is deployed in well-masked battle positions with a brigade size unit. The defender has capability to use precision-guided indirect munitions. Simultaneously, in the whole depth of the attacker's deployment, the defender starts destroying the attacker's units with mines, direct, and indirect fires. After a short period, the attacking brigade is destroyed. During this time, the defender has not conducted any attacks or other offensive actions.

---

<sup>122</sup>Geffory Parker, *Warfare: Cambridge Illustrated History* (New York: Cambridge University Press, 2012), 5.

<sup>123</sup>Both the First and the Second World Wars were ultimately won by offensive operations; the same goes for the majority of the Arab-Israeli wars during the last 50 years.

<sup>124</sup>Switzerland vs Austria 1315-1350; Richard A. Gabriel and Donald W. Boose, *The Great Battles of Antiquity* (Westport, CT: Greenwood Press, 1995), 640. Hezbollah vs Lebanon 2006, Scott C. Farquhar, *Back to Basics: A Study of the Second Lebanon War and Operation CAST LEAD* (Fort Leavenworth, KS: Combat Studies Institute Press, 2009), 6-21.

Would this not be a decisive victory on the tactical level? Even though this example is highly simplified and extreme, it proves that decisive victory, on the tactical level, can theoretically be achieved without offensive movement or attacks. It is, at least in theory, possible to achieve a decisive tactical victory by pure defensive warfighting.

Using this tactical example as a foundation, it is possible to prove that purely defensive warfighting could achieve decisive results on the operational and strategic level as well.

Imagine that the brigade destroyed in the previous example was the only armored brigade available to the attackers, and that it had been reinforced with all of the attacker's available tanks. This would seriously affect the opponent's chance of continuing the attack without reinforcements, which is likely to lead to a decisive result on the operational level as well. Put in another way, if the opponent must attack to achieve his operational goal, defeating those assets capable of attacking will lead to a decisive operational win. Furthermore, imagine that the attacker's population is highly sensitive to casualties, and that the casualties suffered in the tactical brigade-level fight were enough to break their strategic will to fight. This would lead the attacker's government to abort the military operation against the defender, and thus produce decisive victory on the strategic level as well.

This theoretical discussion is not constructed to be realistic; it is a one-sided discussion to show that offensive operations are not the *only* way to achieve decisive victory, even though they, under the right circumstances, might be the way with the highest success rate. This agrees well with such military theorists as Carl von Clausewitz,

who claimed that there are no absolute rules or truths in war; outcomes depend on the individual environment and dynamics that are unique in each individual war.<sup>125</sup>

Moving on to the next question: is a decisive tactical victory by the means of offensive tactics necessary to achieve Sweden's strategic goal in this scenario?

Given the fact that Sweden has been at peace since 1814, and has had no territorial disputes during the last 100 years, it is likely that the opponent will be seen as the aggressor by the international community. This means that the attacker would be under pressure to reach its goals as quickly as possible, before the international community is able to act, as it has done to stop conflicts ranging from the Suez Crisis in 1956 to the Iraqi invasion of Kuwait in 1991. Furthermore, Sweden is a member of European Union, which is likely to put economic and political pressure on an aggressor. In Case 9, the assumption is that the EU will give some kind of military support to Sweden after ten days.

These assumptions suggest that time works for Sweden; the invader must reach his goals as quickly as possible, and thus must have quick decisive tactical victories in order to seize key terrain in Stockholm and win the war. Sweden could achieve its strategic goals simply by denying the opponent decisive victories for 10-15 days, a task that could be achieved without any decisive tactical victories. Therefore, it is not necessary for the Swedish Army to achieve decisive results on the tactical level in order to reach its strategic goals using Case 9.

---

<sup>125</sup>Clausewitz, Chapter 1.

## Chapter Summary

The discussion above is not in any way revolutionary. For a country that has a purely defensive goal - to protect itself and keep its sovereignty - it is enough to get the attacker to realize that the cost of continuing the attack is too high and/or will be unsuccessful. Many countries have maintained their sovereignty without the use of offensive tactics and operations throughout history. Examples range from the early Swiss Confederation in the middle Ages to more recent conflicts such as the Israeli war with Hezbollah in 2006.

This chapter has demonstrated that a decisive victory is not the only way of reaching Sweden's strategic goals, and that the tactical offensive is a risky, and possibly impossible, means of achieving those strategic goals. However, offensive warfare seeking a decisive victory might nonetheless be the most efficient way of achieving Sweden's strategic goals. Therefore, chapter 5 uses a simulation to test the relative merits of offensive and defensive warfare in Case 9. The simulation study demonstrates that defensive attritional tactics are the most efficient way of fighting.

## CHAPTER 5

### SIMULATION RESULTS

#### Chapter Overview

This chapter initially presents the aspects of Case 9 relevant to setting up the simulation scenarios. It then presents and analyzes the results from the offensive and defensive scenarios, demonstrating that defensive warfighting is significantly more efficient for Swedish forces. Thus, the results from the computer simulation support the overall results from Chapter 4. The results show that a Swedish attack against an aggressor results in an engagement with significant losses on both sides, which means that the opponent can use its quantitative superiority to destroy the majority of Swedish forces and reach its operational goal. However, if the Swedish forces fight with defensive tactics, they suffer significantly fewer casualties while inflicting at least as many losses on red as when using offensive tactics. As shown in the chart below, loss ratios are nearly three times more favorable to Sweden when defensive tactics are used. The chart shows a single Swedish loss in black, and the corresponding mean level of Red losses in red, for the two different Swedish tactical approaches: These results shows a significant difference between the two tactical scenarios. There is a two standard deviation difference in loss ratio between the two scenarios, which gives a 95 percent confidence interval.<sup>126</sup>

---

<sup>126</sup>In 95 percent of the cases there will be a difference.

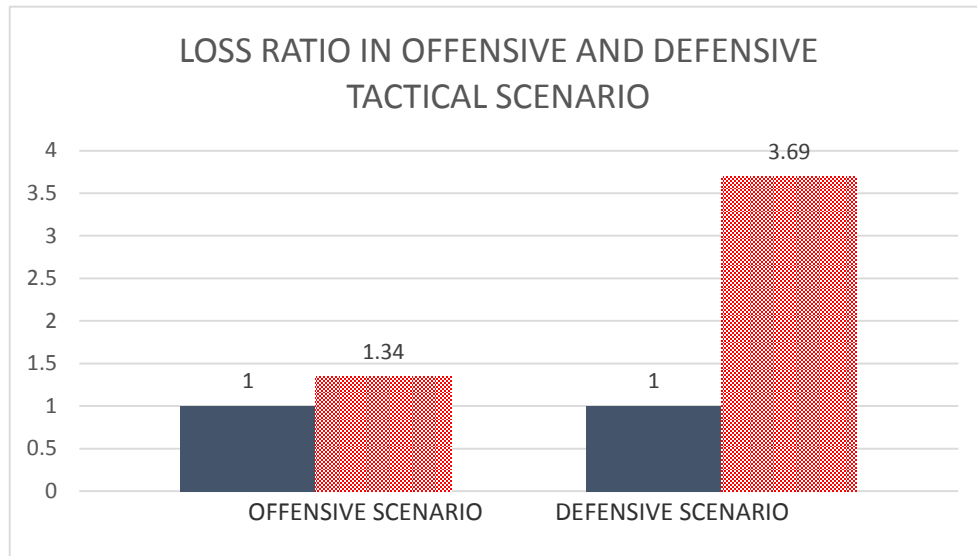

Figure 6. Comparison of total loss ratios

*Source:* Created by author

### Case 9

The simulation focuses on a tactical engagement that is likely to happen when the red side attacks towards Stockholm from one of the SPODs in order to seize key infrastructure. The defending blue side uses offensive tactics in one simulation and defensive tactics in the other. In both cases, blue's purpose is to deny the red side its objective.

Predicting exactly where the first tactical engagement is most likely to take place is impossible; however, the terrain is similar along the whole stretch from the SPODs to Stockholm. The simulation uses Swedish terrain, provided by the Land Warfare Center, which is very similar to the terrain in Case 9. While this terrain is not exactly the terrain



that Case 9 might be fought on, it provides the same tactical problems and opportunities as the actual terrain would.<sup>127</sup>

To get statistically valid results, each of the two tactical situations was simulated 20 times. Each run was supervised by a simulation technician, Mr. Curt Pangracs, to detect any significant software related flaws that resulted in units sometimes losing their programmed orders. Human intervention in the execution phase was kept to an absolute minimum; the only allowed interventions were actions to cause units to continue moving on their programmed paths. Runs that demanded multiple human interventions were eliminated from the study in order to minimize the risk of biases affecting the results.

When interpreting the results, it is vital to remember that simulations of tactical engagements yield widely varying results due to the influence of random actions at low levels. This, in turn, means that the results from the simulations are used to detect overall trends rather than predict exact tactical outcomes. The results are not, and should not be, used to prove detailed cause and effect relationships at the lowest tactical level.

### Orders of Battle

Case 9's blue and red orders of battle were used. There are no guarantees that those organizations are identical in every detail to those found in the real world. Even if they were identical, there are no guarantees that the organizations will remain the same in several years' time. However, even if these organizations change, neither the red nor the blue organizations are likely to change enough to invalidate the simulation results from this study, and thus the results should remain valid for several years.

---

<sup>127</sup>For a more detailed overview of the terrain see map on page 83 and Annex D.

The order of battle of both sides is the same in both the Swedish offensive and the Swedish defensive scenarios. The red side is simulated as a brigade and the blue is simulated as a battalion size unit, simulating a battle between one of the red brigades attacking towards Stockholm, meeting the lead battallion from the Swedish brigade tasked with defeating that offensive.

### Blue Order of Battle

The blue side consists of a reinforced armored infantry battalion, with a command and control/ fire support company, three armored infantry companies, one tank company, and one combat service and support (CSS) company. It has 970 soldiers. Its main fighting force consists of 51 infantry fighting vehicles (IFV), 16 main battle tanks (MBT), 3 recon IFV, 3 12cm mortars, and 3 armored engineer vehicles. The infantry fighting vehicle, the CV9040, is comparable to an M2 Bradley, with a 40mm Bofors cannon instead of a 25mm Bushmaster cannon, and without an AT missile such as the Bradley mounts. The MBT is a Swedish version of the German-built Leopard II (Leopard II A5S) and is comparable to the Abrams M1A2. Both the IFV and the MBT mount 7.62 machine guns (MG) as secondary armament.

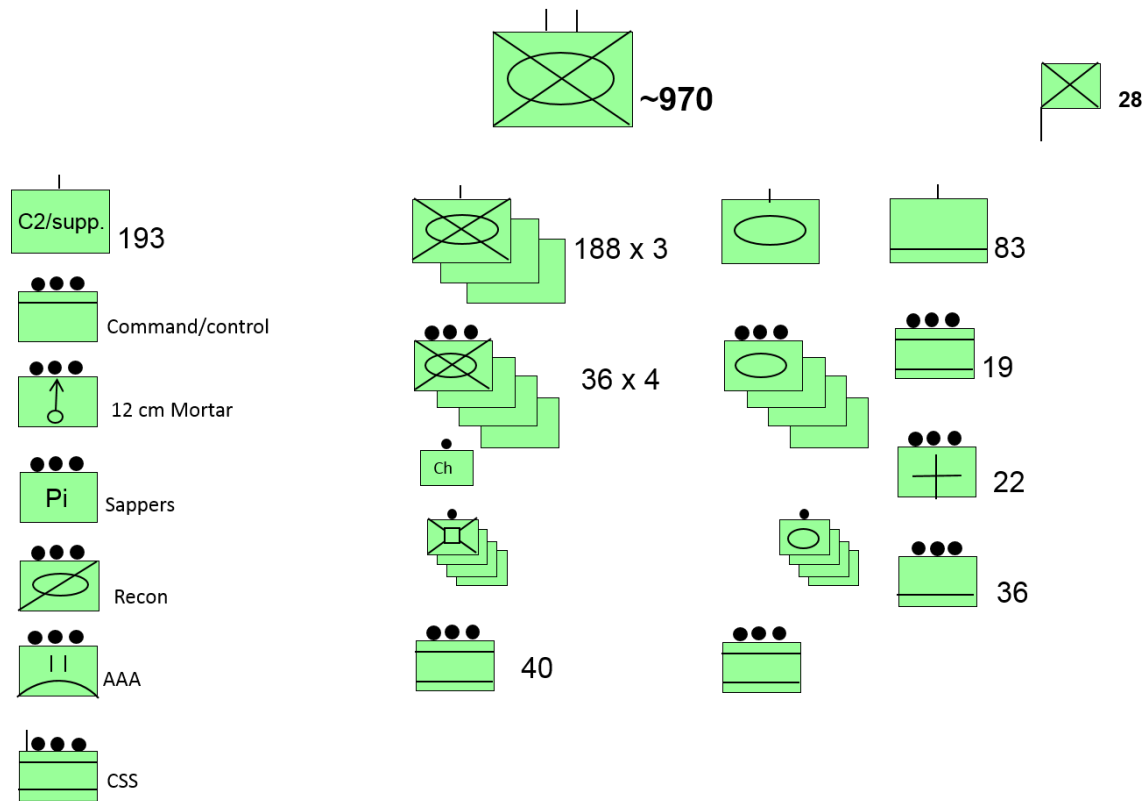

Figure 7. Blue Order of Battle

Source: 9 Appendix A.

### Red Order of Battle

The red side consists of a motorized rifle brigade with three rifle battalions, one tank battalion, one self-propelled howitzer battalion, one engineer battalion, one CSS battalion, and one recon company. It has 4,200 soldiers and its main fighting force consists of 120 BMP-3 IFV, 15 BRDM-AT, 40 T-90 MBT, 36 152mm howitzers, and 18 rocket artillery launchers. The IFV is the BMP-3 armed with a 100mm low-pressure gun capable of firing AT missiles and HEAT grenades, while the BRDM-AT is armed with

an AT-5B ATGM.<sup>128</sup> The BMP-3 also has a 30mm automatic gun and multiple MGs. The T-90 is armed with a 125mm cannon and multiple MGs.

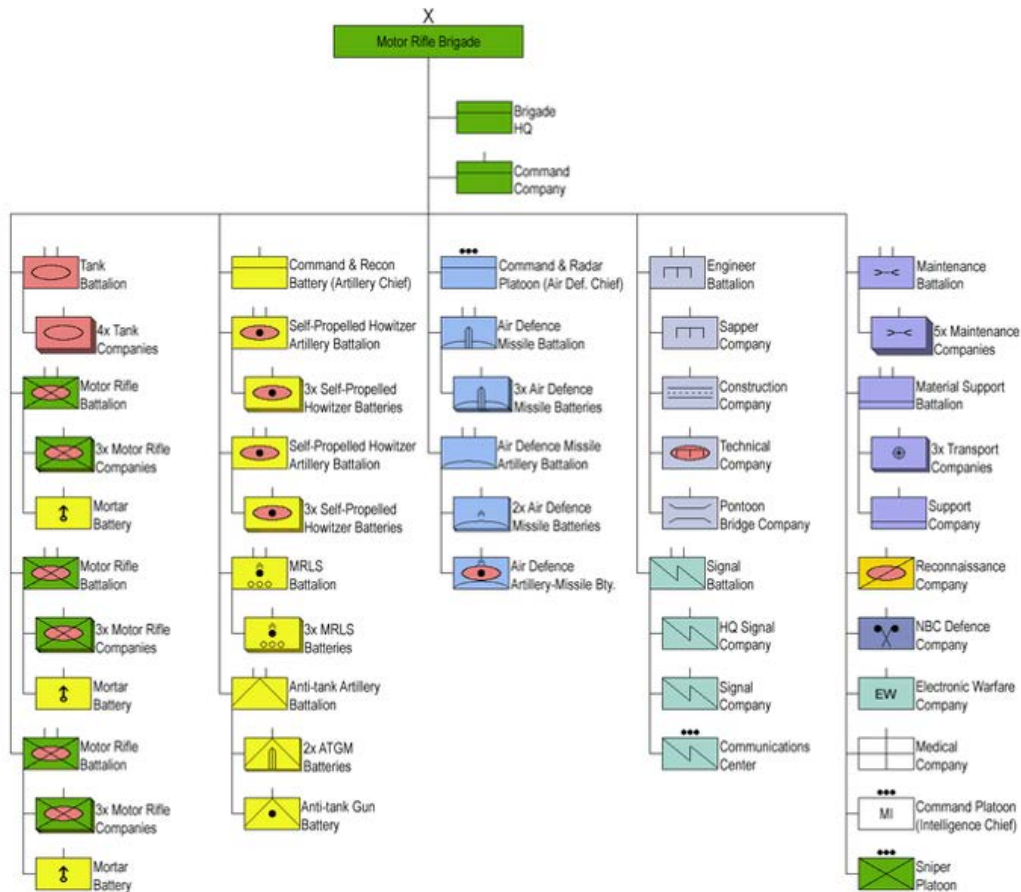

Figure 8. Red Order of Battle

Source: Appendix B.

<sup>128</sup>In the statistics, the BRDM and the BMP-3 are both treated as IFVs.

## Simulation Limitations and Workarounds

Although the intent was to create as realistic a scenario simulation as possible, some issues had to be worked around. Fixed and rotary wing air power was left out of the scenario because of the orders of battle and the assumptions of Case 9. Steel Beasts Pro does not model some of the special capabilities of Swedish indirect fire systems.

There is no rotary or fixed wing aviation, or air defense, in the scenario, because in Case 9, neither side has organic rotary wing air support and it is presumed that Swedish air power is capable of denying the opponent's close air support access to the battle. If the scenario did allow air support, it would be difficult to decide on the type and amount of air support that is reasonable for each side without also deciding which side achieved air superiority. Moreover, the forested terrain makes employment of rotary wing anti-tank missiles problematic, and the terrain also favors the use of the CV9040's 40mm cannon in the anti-helicopter role, for which it was specifically built to provide. Thus, it is not clear that leaving out airpower necessarily favors one side or the other.

Indirect fires are included in the simulation. Except for the blue mortar platoon, the firing positions for indirect systems are deployed outside the simulation map due to distances between the firing system and the targets. Two capabilities are simulated using workarounds. The Swedish Strix heat-seeking anti-tank mortar ammunition is simulated by event-triggered howitzer ICM barrages<sup>129</sup> and the Swedish Archer howitzer system's ability to use Multiple Rounds Simultaneous Impact is simulated by increasing the number of firing units in the simulation by the factor of five.

---

<sup>129</sup>Improved Conventional Munitions, a dual-purpose cluster munition for 155mm howitzer, adapted to use the 12cm mortar range and rate of fire.

The red and blue plans contained minor random variations in order to ensure that no side gained an accidental systemic advantage in the scenario. This could happen, for example, if one side always arrived at a good position at a time that happened to be very favorable for the outcome of a contact.

Both the red and blue battle plans were examined and approved as feasible, suitable, and acceptable by Mr. Steven Scholtz (LTC, US Army, Retired) of the CGSC Department of Tactics, in order to ensure that the author's potential biases were minimized.

#### Simulation: The Swedish Army Uses Offensive Tactics

The purpose of this tactical scenario is to test the current Swedish Army doctrine and its concepts, as described in Chapter 4, within the strategic scenario of Case 9.

According to Swedish doctrine, it is vital to seize the initiative and reach a decisive result by the means of offensive tactics and operations. To achieve this, one of the two Swedish brigades (blue side) has been ordered to attack and seize one of red's two SPODs. The simulation is focused on the lead attacking Swedish battalion. Due to the terrain in the area, the main thrust is canalized along the existing roads leading to one of the SPODs. The battalion commander has chosen to attack with a task-organized lead company, which means that this company consists of MBTs and IFVs that will advance in close co-ordination. If the road is wide enough, two MBTs travel side by side with an IFV on each flank. This tactic is used in order to achieve frontal fire superiority and at the same time protect the MBTs from flanking infantry attacks. When maneuver can only be conducted on the road itself, the IFVs travel just behind the MBTs. In open terrain, the company commander does not use the road at all, but instead attacks using the available

terrain. The lead company is supported by the battalion's mortar platoon and the lead battalion is supported by one of Sweden's two artillery battalions. Indirect fires are pre-planned and will be executed when contact with the opponent occurs.

The lead battalion commander is aware that there is at least a mechanized brigade in the area of the SPOD and he is prepared to take significant losses in order to reach the SPOD and destroy the opponent's sustainment forces and cripple his ability to deploy more units. He will fight aggressively and try to penetrate the opponent's units by massing fires and rapid maneuver. He knows that he must penetrate the opponents' hard units (direct approach) and thus he will try to achieve local superiority before engaging in combat.

The opponent (red side) will attack along the avenue of approach from the SPOD toward the capital, using its recon units to pinpoint enemy positions and call for indirect fires. Behind the recon units, mixed MBT/IFV units will attack. They will try to attack at a high tempo in order to penetrate the blue side's defenses as fast as possible and reach their operational goal. The lead battalion will be supported by the brigade's artillery and MRL units. A fire plan is executed when the attack starts. The red brigade commander knows that there are blue brigade size units in the area. When engaging the blue side, it will mass fires and maneuver units in order to penetrate the blue side and drive as deep as possible. The red side knows that there are additional follow-on red forces coming up behind them.

Due to the numerous water obstacles and wooded terrain, both the red and blue sides choose to mix MBT's and IFV's rather than to mass all their MBTs in one concentrated unit.

Both sides are on the offensive at the beginning of the scenario, and will continue to attack throughout its three-hour duration. It is challenging to decide exactly when one or both sides would stop attacking and shift to the defensive. However, both sides have follow-on forces behind them, which means that they would be likely to continue the offensive even when they have suffered heavy losses. Each scenario run was conducted with both sides attacking during a three-hour timespan. From experience with the scenario, both sides have suffered substantial losses after three hours, and the blue side, at least, will need to reorganize before continuing the attack.



Table 1. Results: Defensive Simulation							
BLUE SIDE run #	Losses MBT	Losses IFV	Losses Personnel	RED	Losses MBT	Losses IFV	Losses Personnel
1	16	43	307		13	65	483
2	15	40	292		10	52	399
3	11	47	347		12	75	546
4	17	50	344		5	85	619
5	16	50	354		10	87	627
6	17	50	352		11	88	605
7	13	51	352		8	95	624
8	16	54	374		4	77	579
9	16	49	339		3	85	607
10	15	51	356		13	88	619
11	17	51	355		5	67	494
12	16	49	329		12	77	547
13	17	49	350		9	102	643
14	15	50	360		9	82	608
14	15	49	339		3	63	432
16	14	47	342		19	91	661
17	16	45	320		22	96	693
18	15	51	359		14	77	636
19	13	48	338		11	92	648
20	15	45	329		0	71	512
<b>MEAN</b>	15.3	48.5	341.9		9.7	80.8	579.1
<b>MEDIAN</b>	15.5	49	345.5		10	83.5	607.5
<b>SD</b>	1.6	3.2	19.22		5.4	12.7	79
<b>2*SD</b>	3.1	6.4	38.44		10.8	25.3	158.1
<b>95% Max Losses</b>	18.4	54.9	380.3		N.A.	106.1	737.2
<b>95% Min Losses</b>	12.2	42	303.5		N.A.	55.4	421

Source: Created by the author.

Not Applicable (N.A.): Red losses varied enough that 2 standard deviations (95 percent confidence interval) out was below zero and higher than the total number of red MBTs.

## The Swedish Offensive: Results

Because of the terrain, both sides had difficulty massing maneuver units to achieve superiority. The terrain also made it difficult for both sides to use maneuver in order to outflank the opponent. The engagement developed into many more or less isolated squad and platoon size engagements. The difficulty of mass and maneuver for both sides lead to significant losses, and neither side succeeded in achieving either a breakthrough or a penetration, with an overall blue: red loss ratio of 1:1.3.

The total losses for the red and blue sides in each of the simulation runs are presented in table1 together with mean, median, and standard deviation.

Blue MBT losses are higher than red's because of the bigger recon forces on the red side. While the blue side is conducting movement to contact without any screen (or by using its lead tank/IFV company. as a screen), the red side is using its BRDM recon units as a screen. This in turn leads to higher IFV losses on the red side, but lower MBT losses. As the table shows, the range of the red MBT losses runs from 0 to 22. The big spread is due to differences in the tactical engagements in each simulation run. The mean red losses are 9.7 with a standard deviation of 5.4 giving a 95 percent confidence interval of 0-20. The blue side's mean is 15.3 with a standard deviation of 1.6. This gives a 95 percent confidence interval of 12-18. The ratio between blue and red is 1.5:1.

The tank units in the blue battalion suffered more than 65 percent losses in all simulation runs and more than 80 percent losses in all but four runs. The red brigade's MBT losses did not exceed 50 percent in any of the simulation runs.

However, the red side paid for its lower MBT losses with higher IFV losses – the red side's IFVs were usually encountered by the blue side's MBTs. Also, due to the

terrain, the red side's IFVs had difficulty using their anti-tank missiles effectively, while the Blue side's CV9040's 40mm automatic cannon with APFSDS-T ammunition is highly efficient in this terrain.<sup>130</sup>

The mean blue losses are 48 IFVs, which corresponds to 82 percent of the battalion's total. Standard deviation on the blue side is 3.2, which gives a 95 percent confidence interval of 42-55.

The mean red IFV losses were 81 vehicles. That corresponds to 57 percent losses in the red brigade. The standard deviation on the red side was 12.66 giving a 95 percent confidence interval of 55-106. The numbers give a loss ratio for the IFVs of 1:1.6.

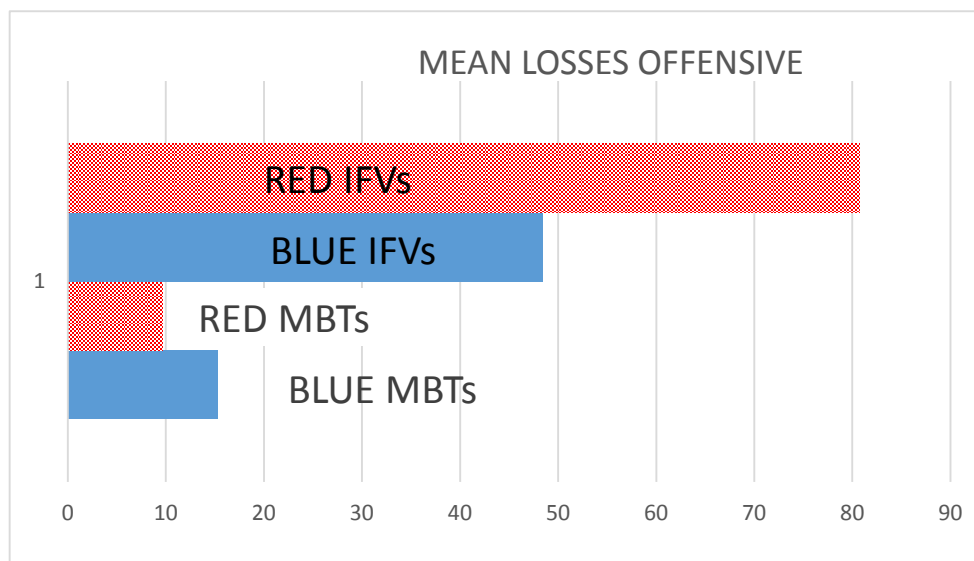

Figure 9. Mean MBT and IFV losses, offensive scenario

Source: Created by author.

<sup>130</sup>Armored Piercing Fin Stabilized Discarding Sabot – Tracer. A penetration optimized munition of the same type as used by MBTs against armored targets.

Because all the units are mechanized, and both sides attacked with soldiers in vehicles, the casualties in soldiers correspond to the IFV losses. The total number of seriously injured and killed soldiers on both sides is shown in the diagram below.

The mean red losses were 579 with a standard deviation of 79, which gives a 95 percent confidence interval of 421-737. The blue mean was 341.9 with a Standard deviation of 19.2 which gives an confidence interval of 311-380. The mean loss ratio is 1:1.7.

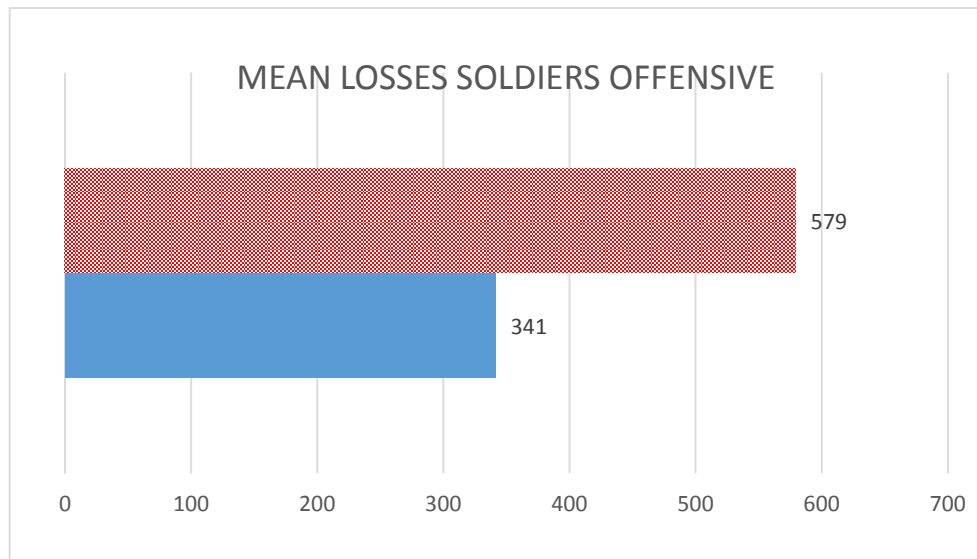

Figure 10. Mean infantry casualties for red and blue side, offensive scenario

Source: Created by the author.

### Offensive Analysis

The blue side is, overall, able to inflict greater casualties than the red side; the ratio in personnel and IFV losses was approximately 1:2 (for each blue casualty there

were two red casualties). The casualty imbalance results, to some extent from the blue side, being able to fight asymmetrically with its MBTs engaging the red side's IFV's. However, this also created high tank losses on the blue side. The difference is also due to the difficulty the red side has in using its long-range anti-tank weapons. The nature of the terrain favors short-range engagements (at 50-500m) which is unsuitable for the majority of the red side's anti-tank systems.<sup>131</sup> The terrain also makes it difficult for the red side to get the full effect of its quantitative superiority.

There were no major terrain gains for either side in this engagement. As mentioned earlier, the fight came down to an attritional engagement with significant losses on both sides. The blue lead battalion was destroyed (over 80 percent vehicle losses) every time, while the red brigade suffered on average approximately 50 percent vehicle losses.

If the battle were to continue, the blue side's brigade has two more battalions to put into the attack while the red side has another two brigades available in reserve.. A purely mathematical analysis suggests that the first and second red brigades would be able to destroy the blue brigade in approximately 9 hours of continuous fighting, albeit with heavy losses. If neither side changed its plan, in theory the blue brigade would be destroyed in another 6 hours and the committed red units would be reduced to the remnants of 2 battalions. Since the second blue brigade is presumed to be engaged elsewhere, holding the rest of the front line against the fourth red brigade, as well as against the naval infantry and air assault forces, Red can commit half of its second brigade and a fresh third brigade through the breach and exploit unimpeded to

---

<sup>131</sup>Both the BRDM's and the BMP-3's main armament is AT-5B and AT-10.

Stockholm. Fighting in this manner, Sweden could conceivably lose the war in three days.

#### Simulation: The Swedish Army Uses Defensive Tactics

In this scenario, the blue side will use defensive tactics by conducting delaying actions with the purpose of inflicting casualties in order to deny the opponent his objective. The blue defense is conducted by multiple attack by fire engagements, combined with indirect fires and mines. Blue has had approximately 6 hours of preparation time that have been used to recon firing positions and re-deployment routes, to register indirect fires, and deploy a small number of anti-tank mines. The initial deployment is shown in Figure 12. The blue battalion consists of the same type and number of units as reported earlier but the commander has task-organized the battalion slightly differently in order to conduct the defense as efficiently as possible. The task organization is shown in figure 11.

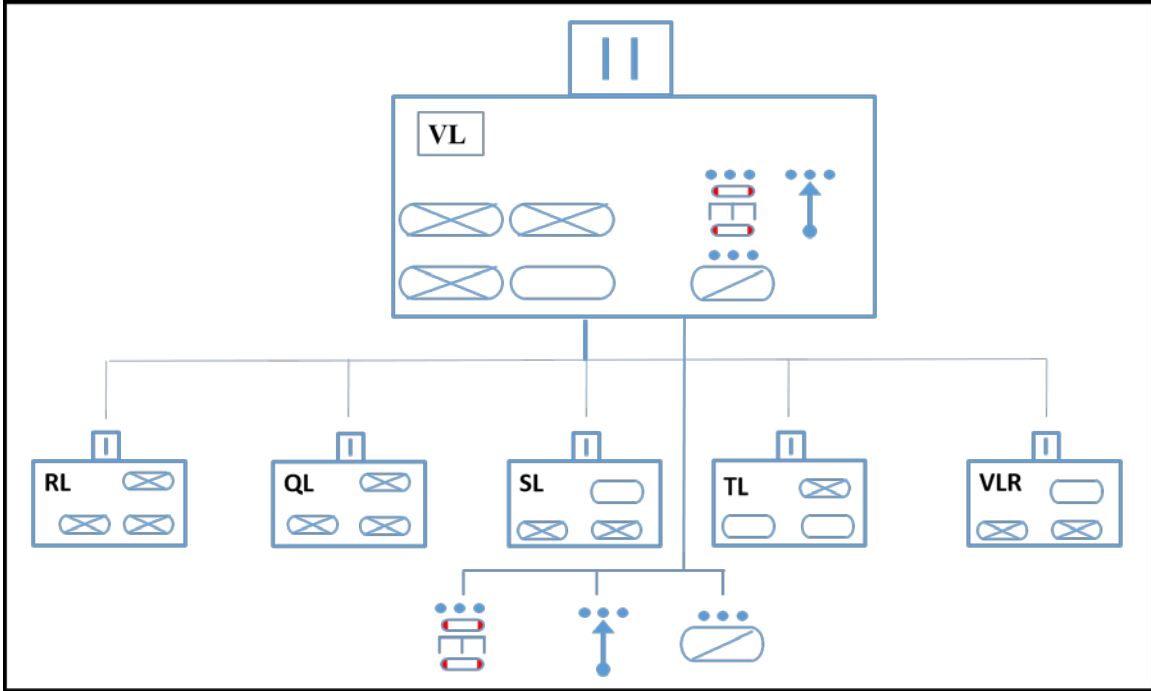

Figure 11. Blue side task organization during the defense

Source: Created by the Author.

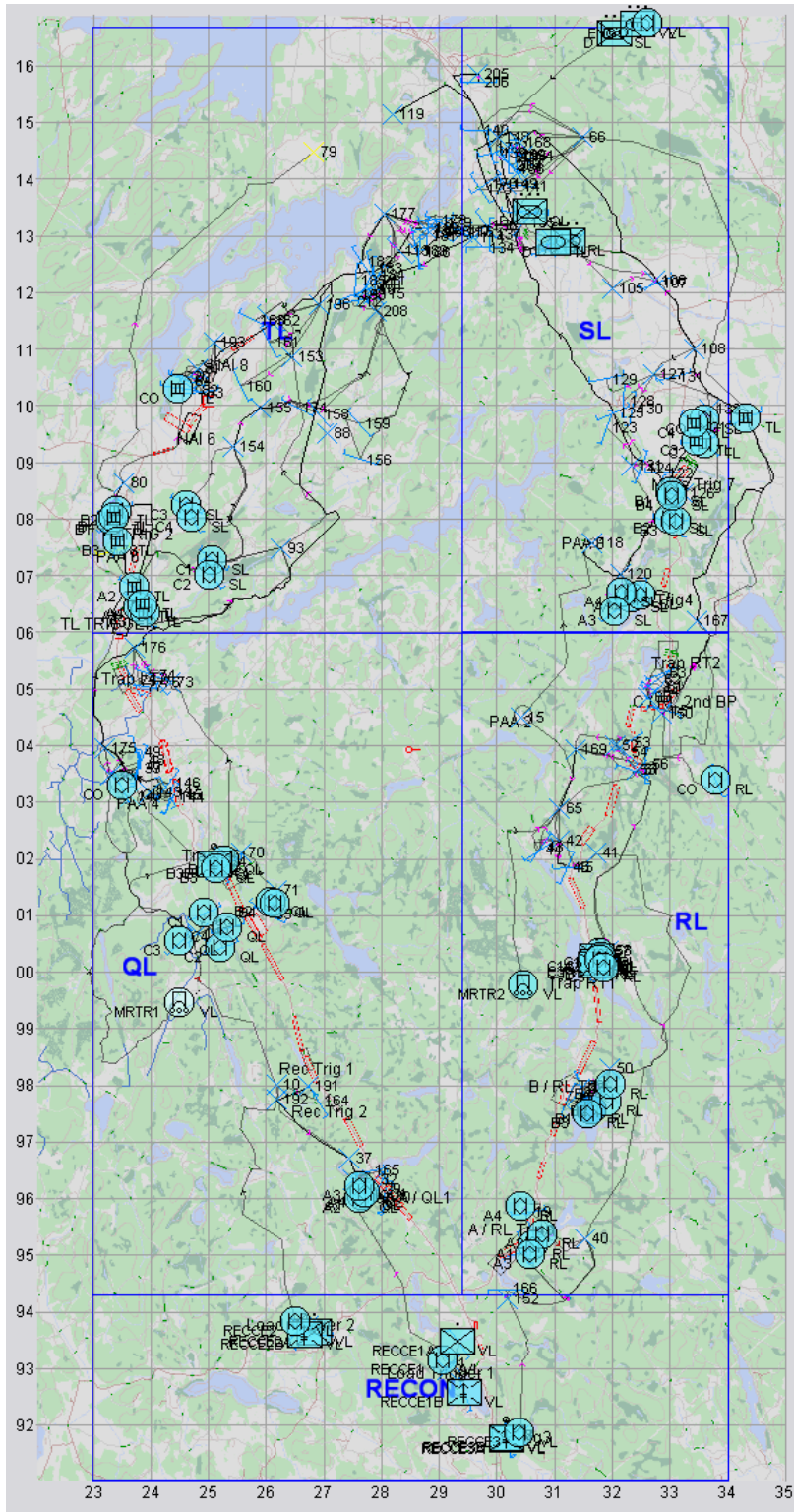

Figure 12. Blue defensive deployment

Source: Created by Mr. Curt Pangracs and the author.



In order to ensure a valid comparison between blue's offensive and defensive tactics, red's units and plans are identical in the two scenarios. The red side consists of the same units, and is task-organized the same way, as in the previous scenario. Red is using an identical plan, with the exact same tactics and combat techniques as in the first scenario. Depending on the level of intelligence available for the red side, it is possible to argue that its tactics ought to be different due to a different blue deployment. However, it is impossible to know exactly which blue action would create a given red reaction. Furthermore, as explained in chapter 4, it is doubtful whether a significantly different attack would be possible in the terrain of the scenario in Case 9.

Table 2. Results: Defensive Simulation							
BLUE SIDE run #	Losses MBT	Losses IFV	Losses Personnel	RED	Losses MBT	Losses IFV	Losses Personnel
1	9	26	201		19	106	642
2	8	26	193		28	111	702
3	7	24	170		20	110	689
4	8	17	130		26	110	665
5	8	17	137		16	106	674
6	1	9	80		7	78	463
7	9	24	173		21	113	708
8	10	19	153		14	79	486
9	8	23	152		19	121	715
10	11	28	198		26	119	699
11	7	25	169		18	105	625
12	11	21	146		22	106	625
13	9	27	195		19	109	669
14	5	20	159		23	103	676
15	5	25	168		20	111	679
16	12	29	204		23	89	637
17	13	29	200		22	115	720
18	6	21	136		10	109	658
19	5	24	172		22	116	698
20	10	21	166		23	108	660
MEAN	8.1	22.8	165.1		19.9	106.2	654.5
MEDIAN	8	24	168.5		20.5	109.0	671.5
SD	2.8	4.8	30.5		5.1	11.6	67.7
2*SD	5.7	9.7	61.1		10.3	23.1	135.5
95% Max Losses	13.7	32.4	226.2		30.2	129.3	790.0
95% Min Losses	2.5	13	103.9		9.6	83.1	519.0

*Source:* Created by author.

Red suffered significantly higher losses than the blue side in the defensive scenario with a mean loss of 20 MBTs (54 percent) compared with a mean loss of 8 (48 percent) of blue MBTs. The standard deviation on red side is 5, which gives a 95 percent confidence interval of 10-30 red MBTs destroyed when the blue side is defending. The

corresponding numbers on the blue side are a standard deviation of 3 which gives a 95 percent confidence interval of 2-14 destroyed blue MBTs. The mean loss ratio for MBTs in this scenario is 1:2.5. The main reason for the red side's higher losses is that the blue side's MBT's usually managed to re-deploy after their first engagement before the red side could direct effective fires towards them.

In IFVs, the red side suffered increased losses in this scenario with a mean loss of 106 IFVs (57 percent) with a standard deviation of 11.56. This gives a 95 percent confidence interval of losses between 83 and 129 IFV for the red side when attacking against a defending blue side. The defender, on the other hand, suffered significantly fewer losses than the red side with a mean loss of 23 IFV (39 percent) with a standard deviation of 4.84, giving a 95 percent confidence interval of 13-32 IFVs destroyed. The mean loss ratio of IFVs in the defense scenario is 1:4.6.

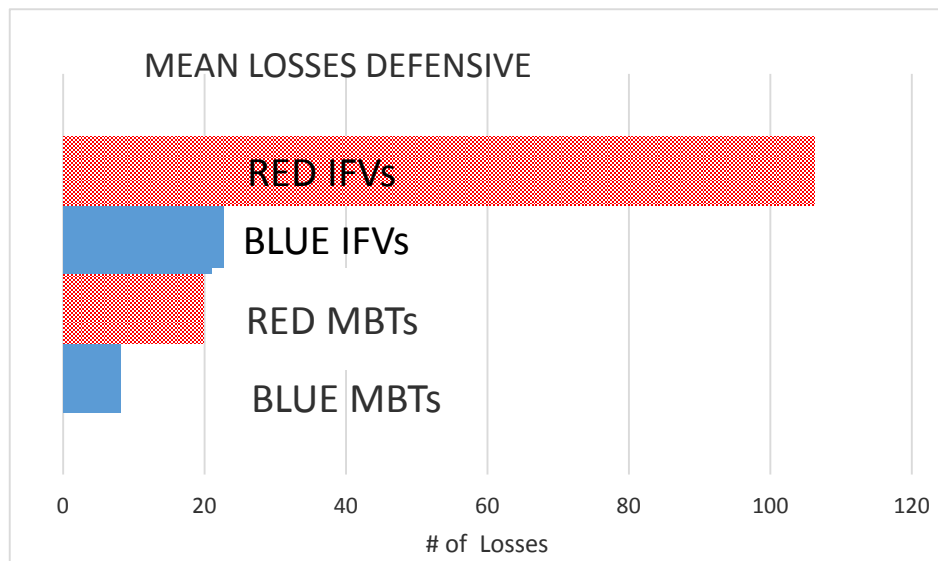

Figure 13. Mean MBT and IFV losses, defensive scenario

Source: Created by author.

Red personnel casualties reach a mean of 654 with a standard deviation of 67.74, which gives a 95 percent confidence interval of losses between 519-789. Blue losses reach a mean of 165 with a standard deviation of 30.5, which gives an interval between 104-226. The mean blue to red loss ratio is 1:4.

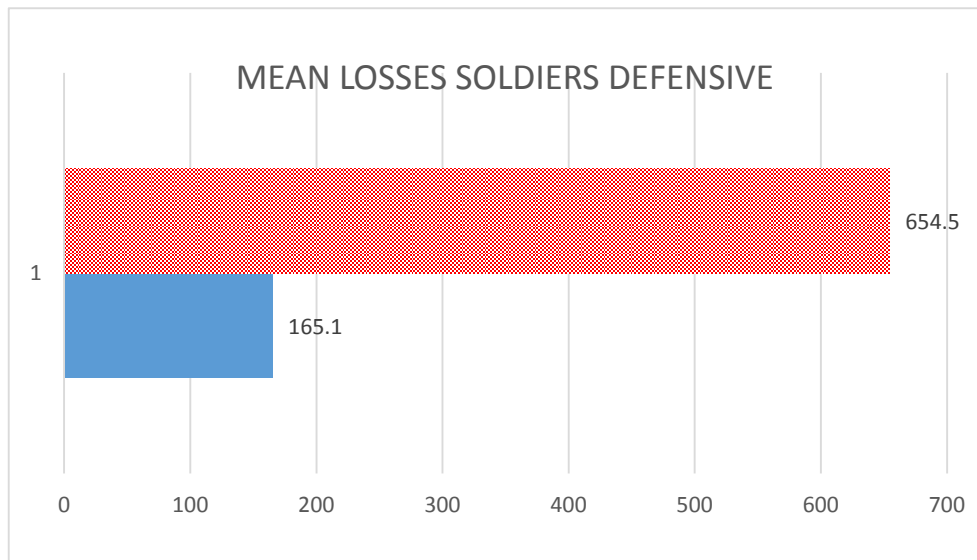

Figure 14. Mean infantry casualties, defensive scenario

Source: Created by Author.

### Defensive Analysis

In addition to the general factors reported in the offensive analysis, the results from the defensive simulation runs reinforce the effects of the canalizing terrain. It is clear that this kind of terrain gives a defender the upper hand, even with limited time for preparation. The terrain offers possibilities for covert redeployments and flanking fire. It also boosts the effects of engineer effort. Even small obstacles and limited use of mines

create significant effects due to the limited ability to move away from the road. The terrain also enables ambush tactics and short range anti-tank weapons by dismounted soldiers, such as the NLAW (RB 57), which inflicts significant casualties on the attacker.

When the blue side used defensive tactics, the red side never succeeded in breaking through the blue defense. Furthermore, even in the simulation run with the highest blue losses, those losses did not exceed 50 percent of IFVs or personnel, though MBT losses exceeded 50% in 9 of the 20 scenario runs. The red brigade suffered approximately 60 percent vehicle losses on average.

The blue side has two more battalions to reinforce the defense while the red side has another two brigades available in reserve. If neither side changes its plan, in theory each blue battalion can destroy one red brigade, and thus the blue brigade will be able to neutralize the initial red brigade and both of the red reserve brigades.<sup>132</sup> The second blue brigade is presumed to be engaged elsewhere, holding the rest of the front line against the fourth red brigade, the naval infantry, and the air assault. The result shown in these simulation runs suggests that red's fourth brigade can be contained by one of blue's battalions, leaving two battalions to hold the line against the naval infantry, and to contain the red air assault battalions. This is clearly a tense situation, but it is far better than assuming, as in the offensive scenario, that the second blue brigade will not be able to contain the fourth red brigade if it attacks. Thus, using defensive tactics, Sweden retains a fighting chance of survival, which is a far better result than the offensive tactics

---

<sup>132</sup>More than 80 percent losses. (The blue battalion will by then be destroyed as well)

scenario outcome, in which it appeared likely that the outcome would be a fresh red brigade attacking Stockholm.

### Conclusions

A simulation is not an exact scientific tool and some might say that tactical engagements are impossible to predict and simulate.<sup>133</sup> However, repeated runs of the simulation point to general trends that validate the results in chapter 4. While there are many uncertain factors in the simulation, as mentioned in chapter 3, the purpose of this simulation is to compare two different ways of fighting for the blue side, not to provide a detailed prediction of the outcome of tactical engagements. The most useful numerical result is the loss ratio between the blue and red sides, which can be used to measure the efficiency of the different blue tactics. This ratio is likely to stay more or less the same, regardless of the total amount of force engaged on the blue and red sides, because the terrain type limits both sides' ability to concentrate firepower. In the table below, the loss ratio for both scenarios shows that defensive tactics are significantly more efficient than offensive ones. Indeed, the loss ratio in the defensive scenario is greater than the commonly acknowledged 3:1 relationship needed to succeed with an attack.

---

<sup>133</sup>LTC. Ola Palmqvist, one of the author of the current Swedish doctrinal believes that the tactical engagements are, first an art and can never become science in the way shown in chapter 5 in this study. (Lt Col Palmqvist, Mail correspondence with author).

Table 3. Total loss ratio in offensive and defensive simulations.		
Type	Offensive	Defensive
MBT (Blue: Red)	1.5:1	1:2.5
IFV (Blue: Red)	1:1.6	1:4.6
Personnel (Blue: Red)	1:1.7	1:4
Overall (Blue: Red)	1:1.3	1:3.7

*Source:* Created by Author.

Mean values have weaknesses in a statistical sense. However, as figure 15 shows, there are significant differences between the offensive and defensive tactics. Even with a margin of two standard deviations (95 percent confidence interval), there is no overlap.

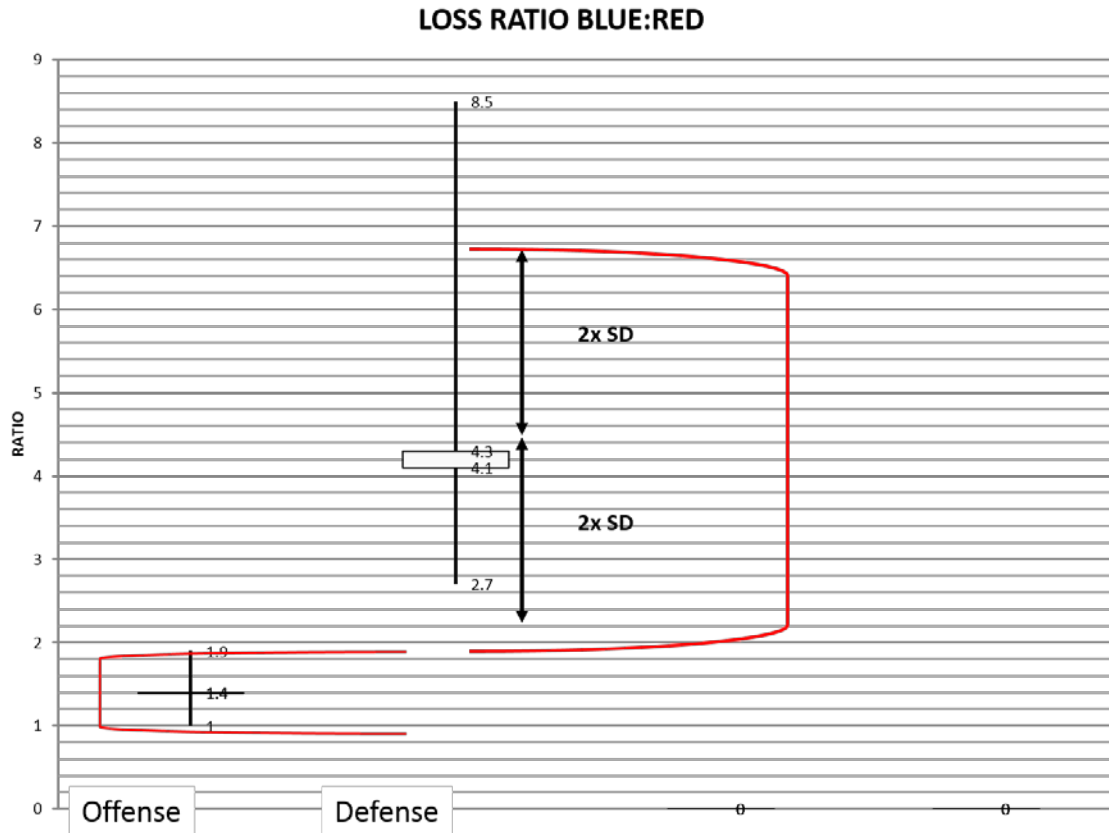

Figure 15. Loss ratio with mean, median, and 2 standard deviation intervals

Source: Created by Dr. James Sterrett, CGSC Simulation Division, and author.

The black vertical lines show the span of loss ratios in the two different tactical scenarios. To the left, the offensive scenario shows that the loss ratio spans from 1:1 to 1:1.9 with a median and mean of 1.4. To the right the black vertical line shows a loss ratio of 2.7- 8.5 with a mean of 4.3 and a median of 4.1. The red brackets show intervals that are two standard deviations wide, which illustrates the non-overlapping results, which means that it is 95 percent likely that the blue side fights significantly more efficiently defensively than offensively. The diagram shows the sum of IFV and MBT losses, which explains the difference from the previous table, where personnel casualties



were included. However as mention before, there are a close correlation between vehicle losses and personal casualties.

The difference between offensive and defensive Swedish tactics is the difference between the Swedish forces remaining combat capable, or not, and thus is the difference between tactical victory and tactical defeat. Furthermore, these tactical results appear to translate to the operational and strategic levels. The offensive scenario outcome tends to produce results that would lead to Sweden being defeated, while the defensive scenario tends to produce results in which Sweden has a reasonable chance of survival. This demonstrates that within the framework of Case 9, defensive tactics are a significantly wiser option for Sweden.

## CHAPTER 6

### CONCLUSIONS, SUMMARY, AND RECOMMENDATIONS

It is dangerous if civilian and military leaders think that maneuver warfare is some kind of miracle medicine.<sup>134</sup>

— *Fundamentals of Military Theory*

#### Results

As shown in the beginning of Chapter 4, the current Swedish Army tactical doctrine clearly favors offensive tactical warfighting. Furthermore, the doctrine makes clear that a decisive result is the only way for Army units to achieve Sweden's operational and strategic goals. It views defensive operations as useful only as shaping operations for future offensive operations.

That chapter also shows that the concepts of maneuver warfare and local superiority, the very concepts the offensive mindset of the doctrine is built upon, will not lead to victory given available forces and other factors within the framework of Case 9. However, chapter 4 also points out that there are other ways than offensive warfighting to achieve decisive results. It also makes the case that it is not necessary for the Swedish Army to conduct offensive operations in order to fulfill the national aims of sovereignty.

Chapter 5 shows that, within the framework of Case 9, fighting according to current doctrine would lead to a defeat for the Swedish forces in three days. Furthermore, it shows that tactics that are more defensive inflict significantly higher casualties on the opponent and, at the same time, provide a hope of survival and therefore victory.

---

<sup>134</sup>Widen and Ångström, 186.

Therefore, the quantitative analysis suggests that a shift from offensive tactics to defensive tactics will improve Sweden's chances of surviving in a conflict such as is shown in Case 9. In addition, the qualitative analysis in chapter 4 demonstrates that offensive operations are not necessarily the only means of achieving decisive victory in the context of Case 9, and neither are offensive tactics necessarily the only means of achieving victory according to military theory. Put together, these suggest that a change to focusing on defensive tactics would make Sweden's current two-brigade structure more likely to be able to meet Sweden's strategic goals.

#### Further Research

In order to avoid imbalance issues in the future it would be highly beneficial to examine why Swedish doctrine failed to adapt to its available forces. This could be done by historical studies as well as through interviews with the authors of the doctrine.

It would be useful to analyze different strategic scenarios to see if the results of this study hold true in more situations.

It would also be interesting to examine the use of Steel Beasts Pro to evaluate tactics on the battalion level in different types of terrain. It is possible that the substantial amount of work already done by Mr. Curt Pangracs could be further refined for similar purposes.

#### Recommendations

This study shows that there is an imbalance between the Swedish army doctrine and available forces. It also shows that the imbalance also occurs between the doctrine and Sweden's strategic goals. There seems to be some shortsighted military thought in

the doctrine, which leads to a disconnect between the prescribed way of fighting on the one hand, and the available resources, the operational environment and the strategic goals on the other hand. The doctrine is too categorical in its statements about the connection between offensive operations, decisive results, and the achievement of strategic goals. It does what the authors of its theory warn about: thinking that maneuver warfare and offensive tactics are the answer to all military problems.<sup>135</sup>

There are two solutions to this imbalance: adapt the number of army units to the ambitious doctrine, or adapt the doctrine to the forces that are available.

As an army officer, it is tempting to suggest the first solution. However, certain defeat of four mechanized brigades would require approximately 12 Swedish maneuver brigades.<sup>136</sup> This number of units would probably require a revival of the compulsory service system as well as a substantial increase in Swedish defense spending. This solution is unlikely. Even though discussions in Sweden, after the events in Ukraine during spring 2014, have caused a temporary reduction in defense cuts, this will most likely not lead to military investments of the size that would be necessary to maintain 12 brigades. Even if it did, the time it takes to re-create the capability to fight according to our current doctrine should drive decision makers to look at other ways to achieve a balance until a substantial increase in Swedish military capability has occurred.

The other alternative, changing the doctrine to defensive tactics, is both feasible and possible. It demands a more nuanced view of maneuver warfare and the need to

---

<sup>135</sup>Widen and Ångström, 143.

<sup>136</sup>Following the usual military doctrinal concept of 3:1 force ratio to attack with prudent risk.

achieve a decisive result. It requires that Swedish maneuver battalions be prepared to fight a mostly defensive battle and that they conduct the necessary preparations for such a fight. Swedish forces must take full advantage of the terrain and deny the opponent a decisive victory. A defensive doctrine would give the Swedish forces a more realistic view of how a successful defense of Sweden is likely to occur. It lowers the risk that those units will find themselves forced to fight with tactics doomed to fail. It will also allow the Swedish Army to fight with its available forces in a more efficient way as well as decrease the risks for a catastrophic failure and a total annihilation.

The first steps on the pathway forward would be to acknowledge that there are ways to gain the initiative in a battle by defensive means, and furthermore to change the view that Sweden needs to reach a decisive victory in order to reach its strategic goals. It would also be beneficial to have realistic examples in the doctrine, in order to enhance Swedish commander's understanding how to achieve local superiority, and of how to conduct maneuver warfare. It is not meant to be a recipe or a checklist, because as mentioned earlier these do not exist. However, understandable and realistic examples can help commander to visualize, and gain deeper understanding of, the doctrinal concepts. It would also be a good idea to mention and describe the risks applicable to the different way's of conducting land operations, in order to provide the reader with a holistic perspective on these different alternatives. This may lead to an increased adaptability and a greater awareness of risk mitigation. Finally, even though it is outside the scope of this study, the author is convinced that if there are assumptions within the Swedish Army's leadership that Sweden will receive military help from a third party, this must be spelled out in Swedish doctrine. This is vital in order to enable all levels to plan and train for

such an event. Furthermore, it would be wise to have actual guarantees of help from a third party in the form of formal treaties or alliances, and not take help for granted without such assurance.

# APPENDIX A

## SWEDISH FORCES

### ARMY UNITS

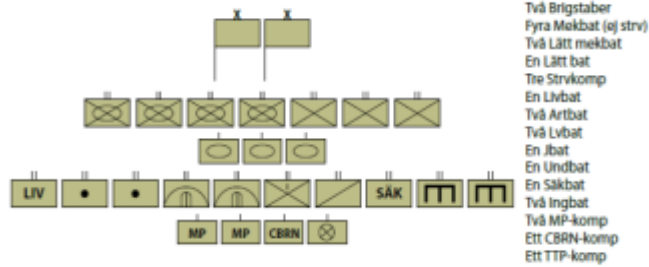

Exempel på förband som agerar tillsammans med Armeförbanden:

#### HEMVARNET

- Hemvärnsbataljon x 40

#### LOGISTIK

- Teknisk bataljon
- Logistikkbataljon x 2
- Sjukhuskompani
- Sjukvårdsförstärkningskompani
- MOVCON
- NSF x 3

#### LEDNING

- Taktisk sambandsbataljon
- Telekrigsbataljon
- Ledningsplatsbataljon
- Psyops pluton
- Operativ ledning

Arméns insatsorganisation 2014.

### OWN ARMY UNITS

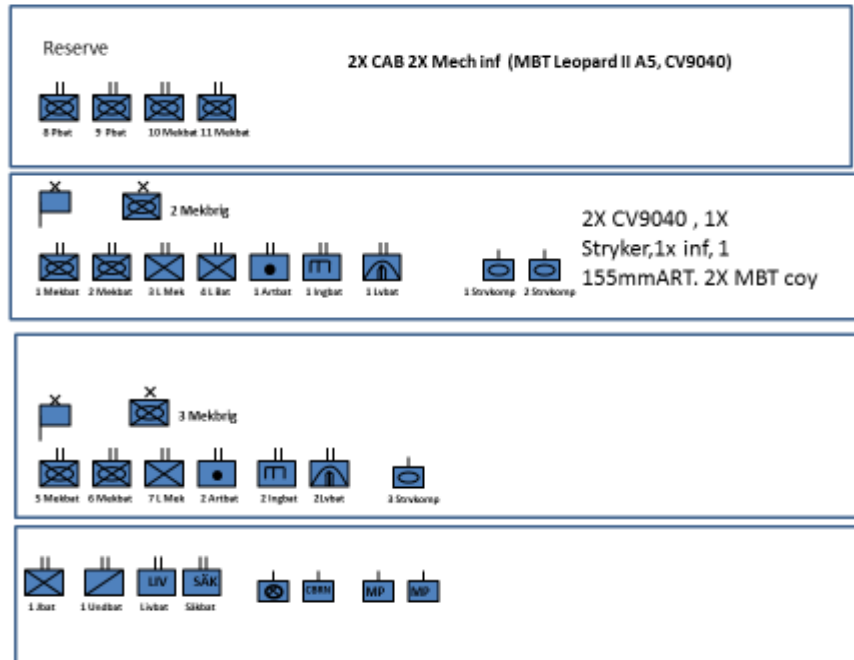



CV 9040  
 40 mm Bofors gun.  
 300 r/min.  
 24 Rounds RTF.  
 APFSDS-T  
 HE  
 Programmable P-HE  
 Integrated c2 system



MBT Leopard 2 A5  
 120 mm  
 APFSDS-T  
 HE

### Re-enforced armored infantry battalion

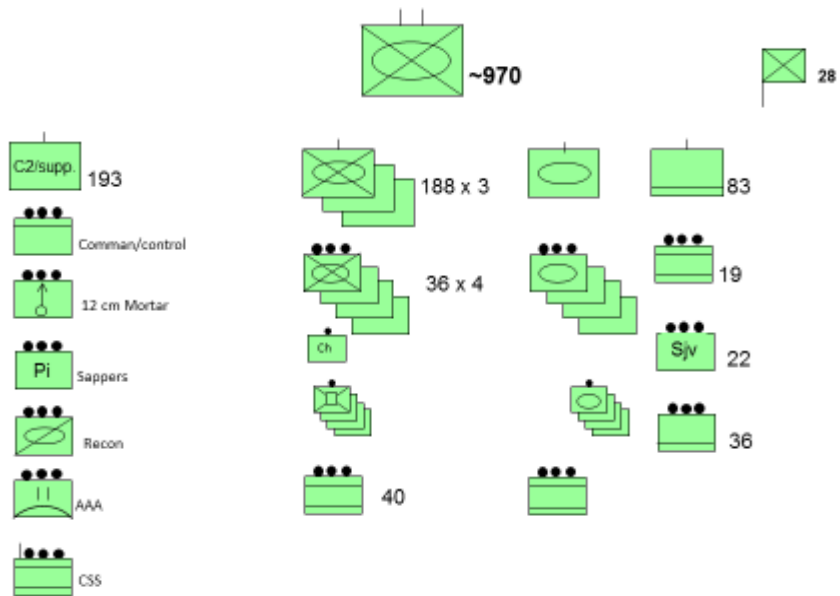



# STRIDSVAGNSKOMPANI 2014

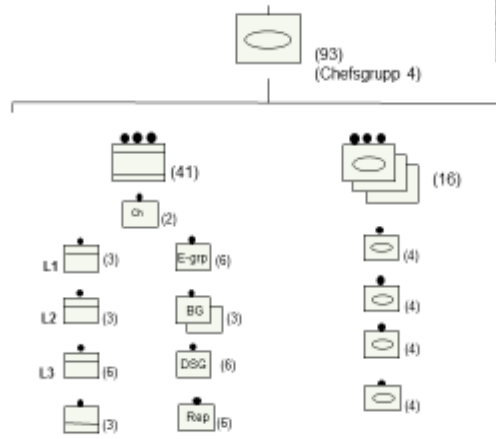

Art 155mm  
HE  
Excalibur  
Range 8-50 km (EX 70)

# APPENDIX B

## OPPONET'S FORCES

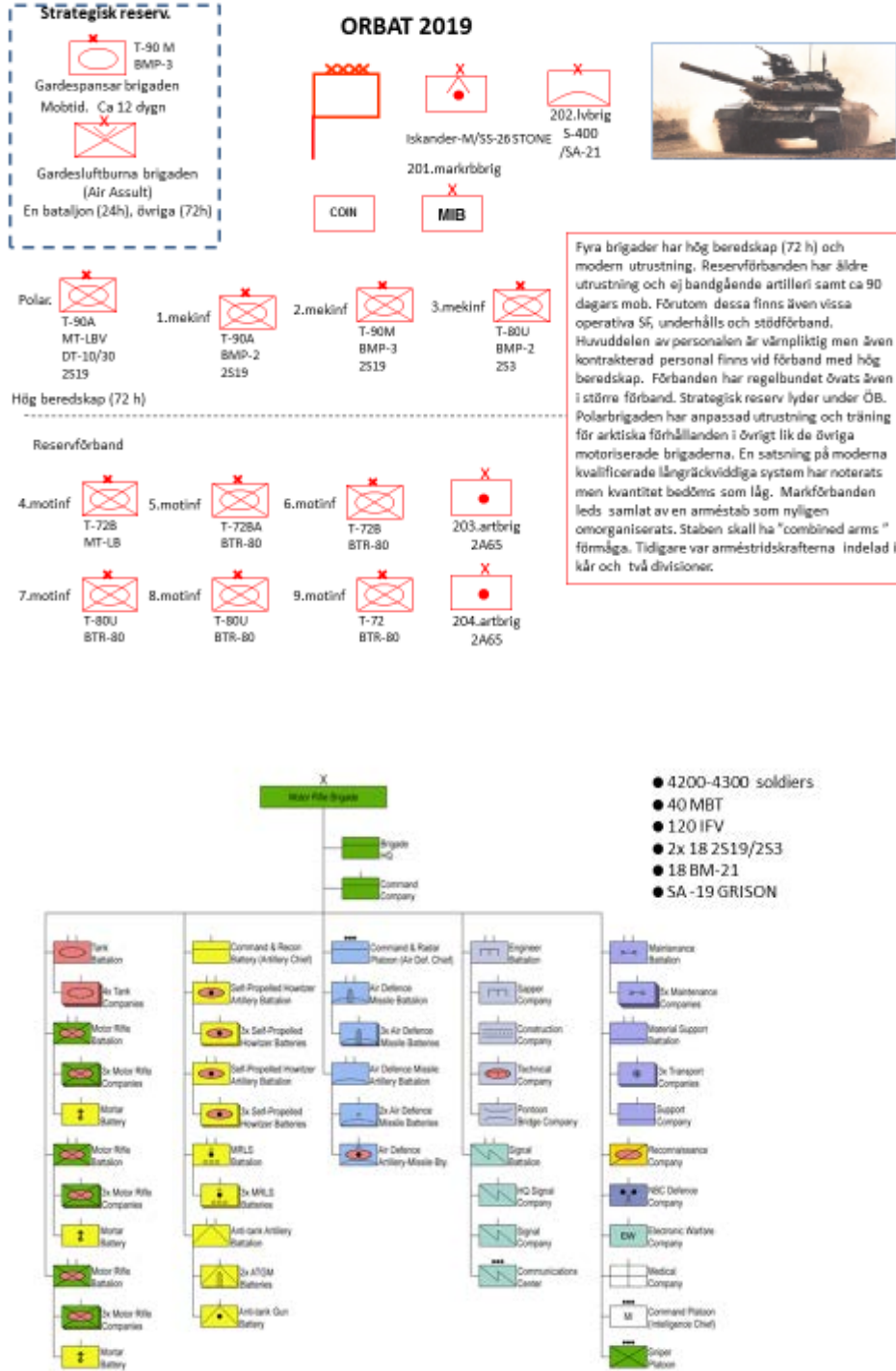

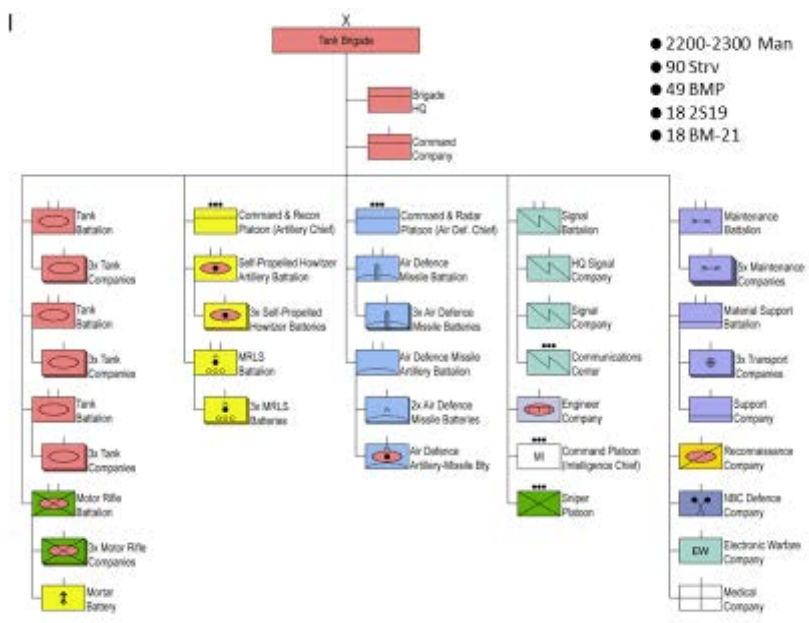

BMP-2

Exempel

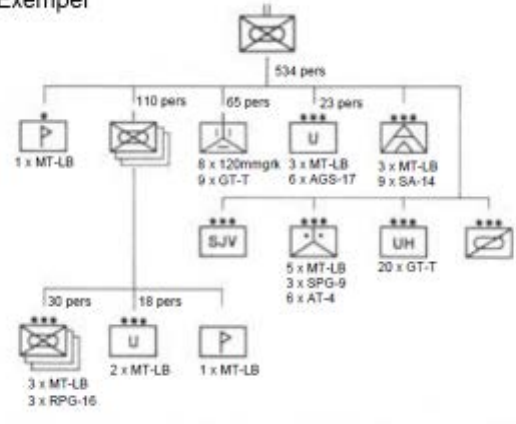

BMP-3



2S3

Exempel

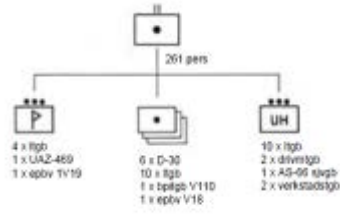

ART BAT

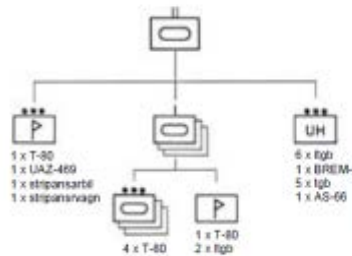

MBT BAT



SA-13 Grisen/Tunguka



2S19 (152mm)



T-90



Pantsir-S1



D-30

*Fordonen och bestyckningen kan skifta beroende på brigadtillhörighet.*

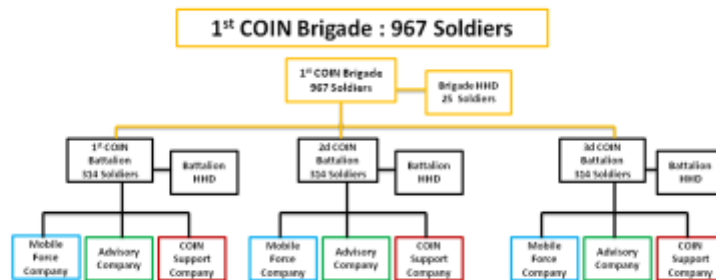

## APPENDIX C

### SWEDISH COMMANDER'S INTENT

## Slutsatser

- Vi skall så snabbt som möjligt påverka motståndarens förmåga till anfall mot Stockholm.
- För att lyckas med detta måste vår egen rörlighet genom Stockholm samt söder och norr om Mälaren bibehållas eller skapas.
- Vi har gynnsammast styrkeförhållanden perioden 14-17 Feb.
- Enkla och tydliga ledningsförhållanden är ett måste med hänsyn till tidsfaktorn.
- I det inledande skedet prioriteras ett högt tempo före samordning. I de senare skedet prioriteras en hög grad av samordning syftande till högre säkerhet och eldkraft.

## BIS/GFI

- *Inledningsvis* skall brigad S mälaren ta JÖNÅKER-VAGNSHÄRAD i syfte att hindra fiendens utbredning från OXELÖSUND. Samtidigt skall tillgängliga delar ur brigad som anländer N Mälaren förstärka förband ur MRM som nu genomför fördröjningstrid längs väg 74 i syfte att fördröja fiendens utbredning från NYNÄSHAMN i N riktning. I detta skede skall JBAT inhämta/ störa mot motståndaren NYNÄSHAMN samt UNDBAT inhämta / störa mot OXELÖSUND.
- *Därefter* skall brigad S Mälaren isolera motståndaren i OXELÖSUND, härvid skall egen rörlighet S Södertälje säkerställas. Brigad N Mälaren skall ta VÄSTERHANINGE-SIBBLE i syfte att hindra motståndarens utbredning i N samt NV riktning.
- *Slutligen* skall brigad S Mälaren vara beredd att med del återta övergångarna SÖDERTÄLJE. Brigad N Mälaren skall i detta skede isolera motståndaren NYNÄSHAMN samt vara beredd att med del ta övergångarna SÖDERTÄLJE.
- *I ett senare skede* skall samtliga förband vara beredda att slå fientliga förband I MÄLARDALEN.

## Riktlinjer

- I det inledande skedet prioriteras ett högt tempo före samordning i syfte att förhindra motståndarens utbredning. I de senare skederna prioriteras en hög grad av samordning syftande till högre säkerhet och eldkraft.

## MÅLBILD

- När uppgiften är löst är motståndaren Isolerad i OXELÖSUND samt NYNÄSHAMN med reducerad styrketillväxt.
- Vi behärskar Stockholm samt har rörelsefrihet inom MÄLARDALEN. Vi har förmåga att slå fientliga förband i bataljons storlek inom MÄLARDALEN.

## Ledning

- 8 P.bat samt 10.mekbat samt underställs 2.brig vid egen slutpunkt tills vidare.
- Und bat uderställs 2:brig from 02-11 tills vidare.
- 9 Pbat samt 11 Mekbat underställs 3.brig vid egen slutpunkt tills vidare.
- Jbat underställs 3.brig from 02-11 tills vidare.

## APPENDIX D

### SIMULATION DATA (DVD)

For a copy of the Simulation DVD, contact the CARL Library Archive Department at (913) 758-3053 or email [usarmy.leavenworth.tradoc.mbx.cgsc-carl-reference@mail.mil](mailto:usarmy.leavenworth.tradoc.mbx.cgsc-carl-reference@mail.mil)



## BIBLIOGRAPHY

### Problem Framing Literature

- Eikmeier, Dale C. "A Logical Method for Center-Of-Gravity-Analysis." *Military Review* (September-October 2007). Reprinted in US Army Command and General Staff College, C406RB1. Fort Leavenworth, KS: USACGSC, November 2013.
- Försvarmakten. *Arme Reglemente Taktik 2013* [SAF, Tactical Army Regulation 2013]. Stockholm: Försvarmakten, 2013.
- . *Dmarko2002*. [SAF, Doctrine for Land Operations 2002]. Stockholm: Försvarmakten, 2002.
- . *Markstridsreglemente 6.Bataljon. R FM MSR 6 Manöverbat FU* [SAF, Regulation for Land Warfare 6 Maneuver Battalions]. Stockholm: Försvarmakten, 2013
- . *Militärstrategisk doktrin 2012* [Doctrine on Military Strategy]. Stockholm: Försvarmakten, 2011.
- Lykke, Arthur F. Jr. "Military Strategy: Theory and Application." Research paper US Army War College, Carlisle, PA. 1998.
- Posen Barry R. *The Sources of Military Doctrine: France Britain and Germany between the World Wars*. Ithaca, NY: Cornell University Press, 1984.
- Svenska Dagbladet. "Försvär med tidsgräns." 12/30 2012.  
[http://www.svd.se/nyheter/inrikes/forsvar-med-tidsgrans\\_7789308.svd](http://www.svd.se/nyheter/inrikes/forsvar-med-tidsgrans_7789308.svd) (accessed 9 November 2013).
- Usenashvili, David, "Strategic Capability Review of the Georgian Armed Forces." Master's thesis, Command and General Staff College, Fort Leavenworth, KS, 2012.
- Wallen, Andrew T. "Why Resources Management Doctrine." *Air Force Comptroller* 37, no. 3 (July 2007).

### Methodology Supporting Literature

- Banks, Jerry, John S. Carson II, Barry L. Nelson, and David M. Nicol. *Discrete-Event System Simulation*, 5th ed. New Jersey: Pearson Education, 2010.
- Department of the Army. *Army Regulation 5-11, Management of Army Models and Simulations*. Washington, DC: Government Printing Office, 2005.

———. Pamphlet 5-11, *Verification, Validation and Accreditation of Army Models and Simulations*. Washington, DC: Government Printing Office, 1999.

———. Training Circular (TC) 7-100.2. Washington, DC: Government Printing Office, December 2011.

Department of Defense. *Modeling and Simulation Related Standards and Best Practice Guide*. Washington, DC: Government Printing Office, October 2010.

House, Jonathan M. *Toward Combined Arms Warfare: A Survey of 20th-Century Tactics, Doctrine and Organization*. Leavenworth, KS: Combat Studies Institute, 1984.

Huff, Darrell. *How to Lie with Statistics*. Penguin Books, 1973.  
<https://archive.org/details/HowToLieWithStatistics> (accessed 11 October 2013).

Luttwak, Edward N. *Strategy: The Logic of War and Peace*. Cambridge, MA: Belknap Press, 2001.

Reinhart, Alex. “Statistics Done Wrong: The Woefully Complete Guide.” Web based book. <http://www.refsmmat.com/statistics/index.html>- (accessed 11 November 2013).

Meriam, Sharan B. *Qualitative Research: A Guide to Design and Implementation*. San Francisco: John Wiley and Sons, 2009.

Swedish National Defense College. *Case 9*, Fictitious scenario used in this study.

Widen Jerker, and Jan Ångström. *Militärteorins Grunder* [The Foundations of Military Theory]. Stockholm: Försvarsmakten, 2004.

### Historical Literature

Clausewitz, von Carl. *On War*. Edited and translated by Michael Howard and Peter Paret. Princeton, NJ: Princeton University Press, 1984.

Farquhar Scott C. *Back to Basics: A Study of the second Lebanon War and Operation CAST LEAD*. Fort Leavenworth, KS: Combat Studies Institute Press, 2009.

Gabriel, Richard A., and Donald W.Boose. *The Great Battles of Antiquity*. Westport, CT: Greenwood Press, 1995.

Herzog, Chaim. *The Arab-Israeli Wars*. New York: Random House, 1982.

Parker Geffory, *Warfare: Cambridge Illustrated History*. New York: Cambridge University Press, 2012.

## Simulation

Steel Beasts Pro 3™, eSim Game 2013.